

PEFY-M20, 25, 32, 40, 50, 63, 71, 80, 100, 125, 140VMA-A

Unit: mm

[Maintenance access space]
Secure enough access space to allow for the maintenance, inspection, and replacement of the motor, fan, drain pump, heat exchanger, and control box in one of the following ways.
Select an installation site for the indoor unit so that its maintenance access space will not be obstructed by beams or other objects.

(1) When a space of 300mm or more is available below the unit between the unit and the ceiling. (Fig.1)

- Create access door 1 and 2 (450×450mm each) as shown in Fig.2.
- (Access door 2 is not required if enough space is available below the unit for a maintenance worker to work in.)

(2) When a space of less than 300mm is available below the unit between the unit and the ceiling.

(At least 20mm of space should be left below the unit as shown in Fig.3.)

- Create access door 1 diagonally below the control box and access door 3 below the unit as shown in Fig.4.
- or
- Create access door 4 below the control box and the unit as shown in Fig.5.

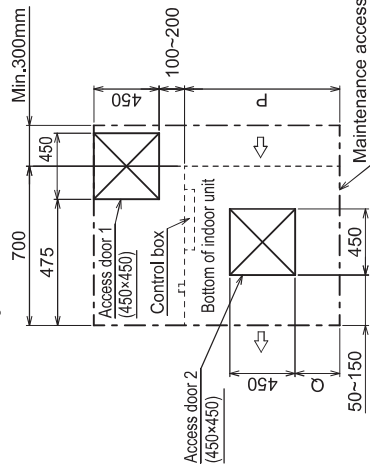
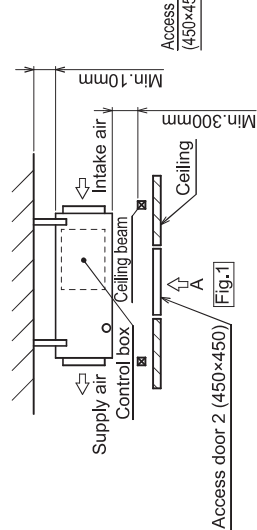

[Fig.2] (Viewed from the direction of the arrow A)

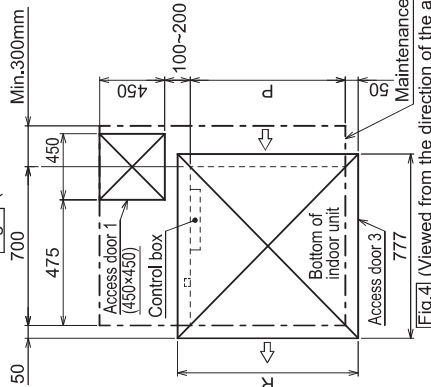

[Fig.4] (Viewed from the direction of the arrow B)

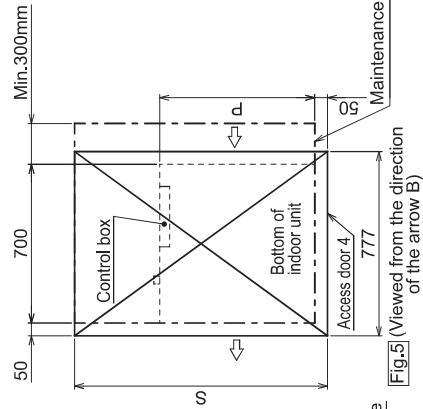
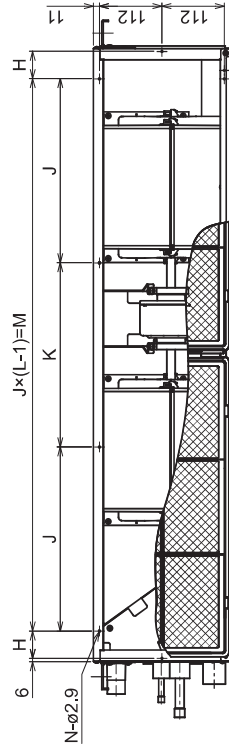

[Fig.5] (Viewed from the direction of the arrow B)

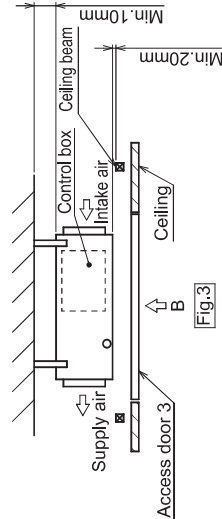

[Fig.3]

Model	H	J	K	L	M	N	P	Q	R	S
PEFY-M20, 25, 32VMA-A	44	150	300				700	50~150	800	1300
PEFY-M40, 50, 63VMA-A	54	260		4	780	10	900	150~250	1000	1500
PEFY-M71, 80VMA-A	49	330		4	990	10	1100	250~350	1200	1700
PEFY-M100, 125VMA-A	54	320		5	1280	12	1400	400~500	1500	2000
PEFY-M140VMA-A	54	370		5	1480	12	1600	500~600	1700	2200

2. EXTERNAL DIMENSIONS

Ceiling concealed (Medium static pressure type)

PEFY-M20, 25, 32, 40, 50, 63, 71, 80, 100, 125, 140VMA-A Suction filter box built-in-specification

Unit: mm

- Note
1. Use M10 screw for the Suspension bolt (field supply).
 2. Keep the service space for the maintenance at the bottom.
 3. This chart indicates for PEFY-M71~80VMA-A models, which have 2 fans. PEFY-M20~25~32VMA-A models have 1 fan. PEFY-M40~50~63VMA-A models have 2 fans. PEFY-M100~125~140VMA-A models have 3 fans.
 4. Use air filter installed with indoor unit.

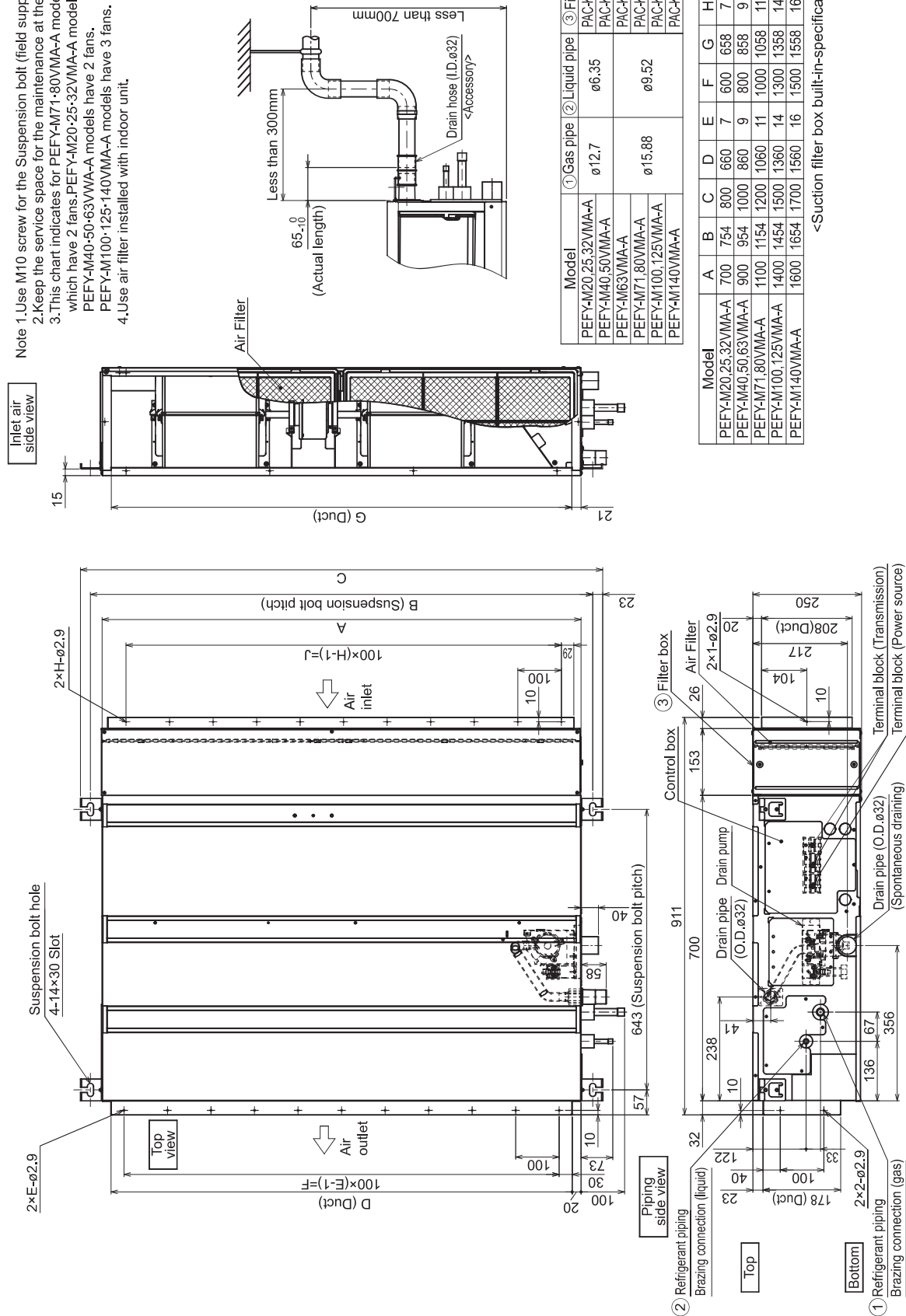

Model	① Gas pipe	② Liquid pipe	③ Filter box
PEFY-M20,25,32VMA-A	ø12.7	ø6.35	PAC-KE91TB-E
PEFY-M40,50VMA-A			PAC-KE92TB-E
PEFY-M63VMA-A			PAC-KE93TB-E
PEFY-M71,80VMA-A	ø15.88	ø9.52	PAC-KE94TB-E
PEFY-M100,125VMA-A			PAC-KE95TB-E
PEFY-M140VMA-A			PAC-KE96TB-E

Model	A	B	C	D	E	F	G	H	J
PEFY-M20,25,32VMA-A	700	754	800	660	7	600	658	7	600
PEFY-M40,50,63VMA-A	900	954	1000	860	9	800	858	9	800
PEFY-M71,80VMA-A	1100	1154	1200	1060	11	1000	1058	11	1000
PEFY-M100,125VMA-A	1400	1454	1500	1360	14	1300	1358	14	1300
PEFY-M140VMA-A	1600	1654	1700	1560	16	1500	1558	16	1500

<Suction filter box built-in-specification>

PEFY-M20, 25, 32, 40, 50, 63, 71, 80, 100, 125, 140VMA-A Suction filter box built-in-specification

Unit: mm

[Maintenance access space]
Secure enough access space to allow for the maintenance, inspection, and replacement of the motor, fan, drain pump, heat exchanger, and control box in one of the following ways.
Select an installation site for the indoor unit so that its maintenance access space will not be obstructed by beams or other objects.

- (1) When a space of 300mm or more is available below the unit between the unit and the ceiling. (Fig.1)
 - Create access door 1 and 2 (450×450mm each) as shown in Fig.2.
 - (Access door 2 is not required if enough space is available below the unit for a maintenance worker to work in.)
- (2) When a space of less than 300mm is available below the unit between the unit and the ceiling. (At least 20mm of space should be left below the unit as shown in Fig.3.)
 - Create access door 1 diagonally below the control box and access door 3 below the unit as shown in Fig.4.
 - or
 - Create access door 4 below the control box and the unit as shown in Fig.5.

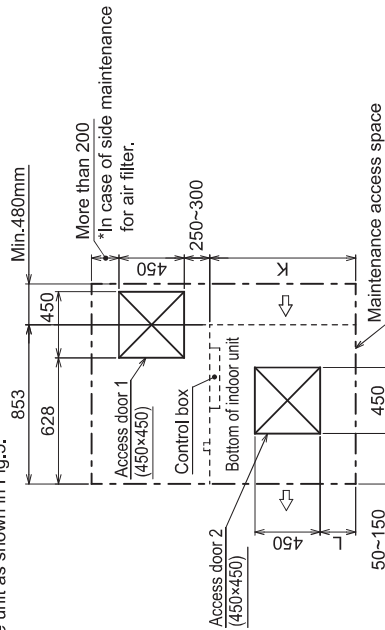
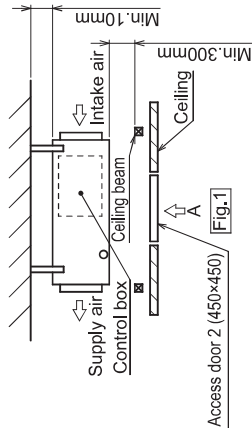

Fig.2 (Viewed from the direction of the arrow A)

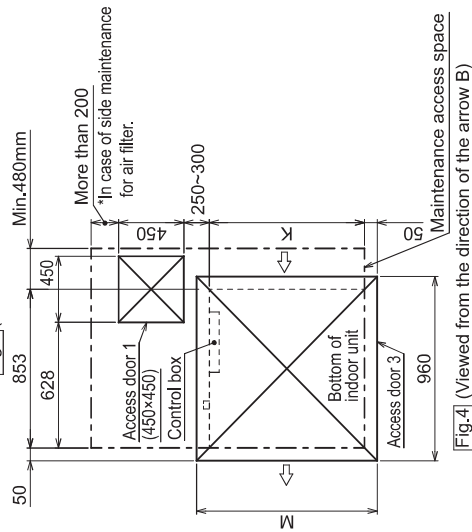

Fig.4 (Viewed from the direction of the arrow B)

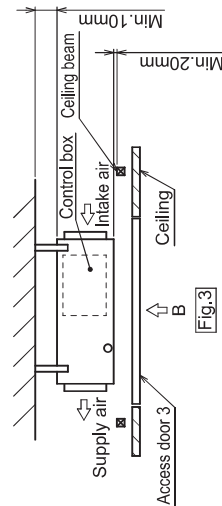

Fig.3

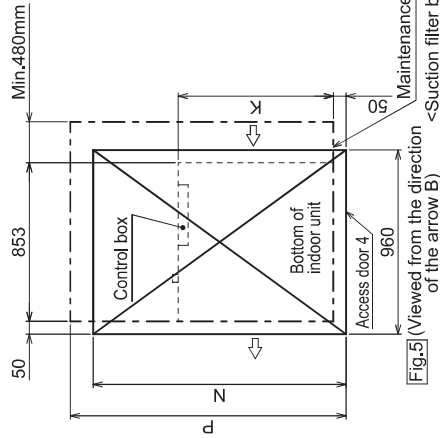

Fig.5 (Viewed from the direction of the arrow B) <Suction filter box built-in-specification>

* Dimension 'P' is in case of side maintenance for air filter.

Model	K	L	M	N	P*
PEFY-M20, 25, 32VMA-A	700	50~150	800	1300	1450
PEFY-M40, 50, 63VMA-A	900	150~250	1000	1500	1850
PEFY-M71, 80VMA-A	1100	250~350	1200	1700	—
PEFY-M100, 125VMA-A	1400	400~500	1500	2000	2150
PEFY-M140VMA-A	1600	500~600	1700	2200	2550

2. EXTERNAL DIMENSIONS

Ceiling concealed (Medium static pressure type)

PEFY-M20, 25, 32, 40, 50, 63, 71, 80, 100, 125, 140VMAL-A

Unit: mm

- Note 1. Use M10 screw for the Suspension bolt (field supply).
 2. Keep the service space for the maintenance at the bottom.
 3. This chart indicates for PEFY-M71·80VMAL-A models, which have 2 fans. PEFY-M20·25·32VMAL-A models have 1 fan. PEFY-M40·50·63VMAL-A models have 2 fans. PEFY-M100·125·140VMAL-A models have 3 fans.
 4. In case of the inlet duct is used, remove the air filter (supply with the unit), then install the filter (field supply) at suction side.

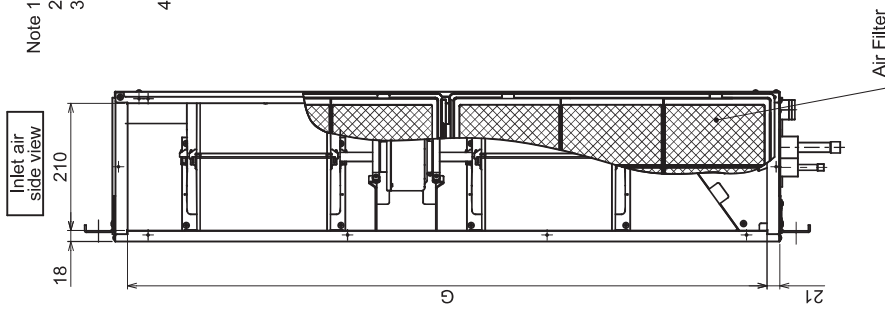
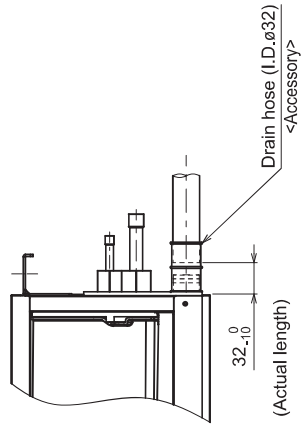

Model	A	B	C	D	E	F	G	① Gas pipe	② Liquid pipe
PEFY-M20, 25, 32VMAL-A	700	754	800	660	7	600	658	ø12.7	ø6.35
PEFY-M40, 50VMAL-A	900	954	1000	860	9	800	858		
PEFY-M63VMAL-A	900	954	1000	860	9	800	858		
PEFY-M71, 80VMAL-A	1100	1154	1200	1060	11	1000	1058	ø15.88	ø9.52
PEFY-M100, 125VMAL-A	1400	1454	1500	1360	14	1300	1358		
PEFY-M140VMAL-A	1600	1654	1700	1560	16	1500	1558		

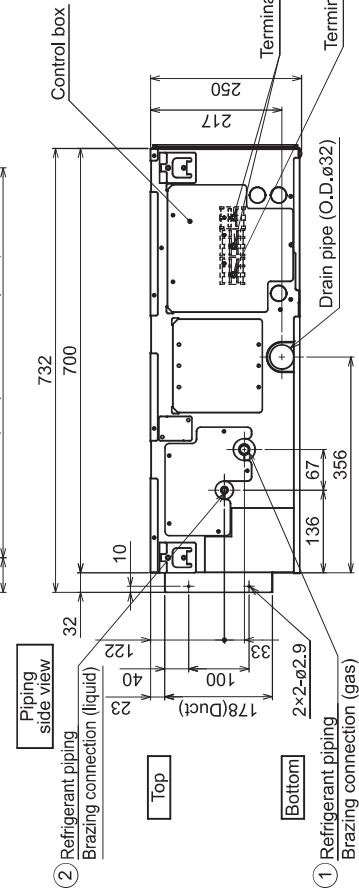
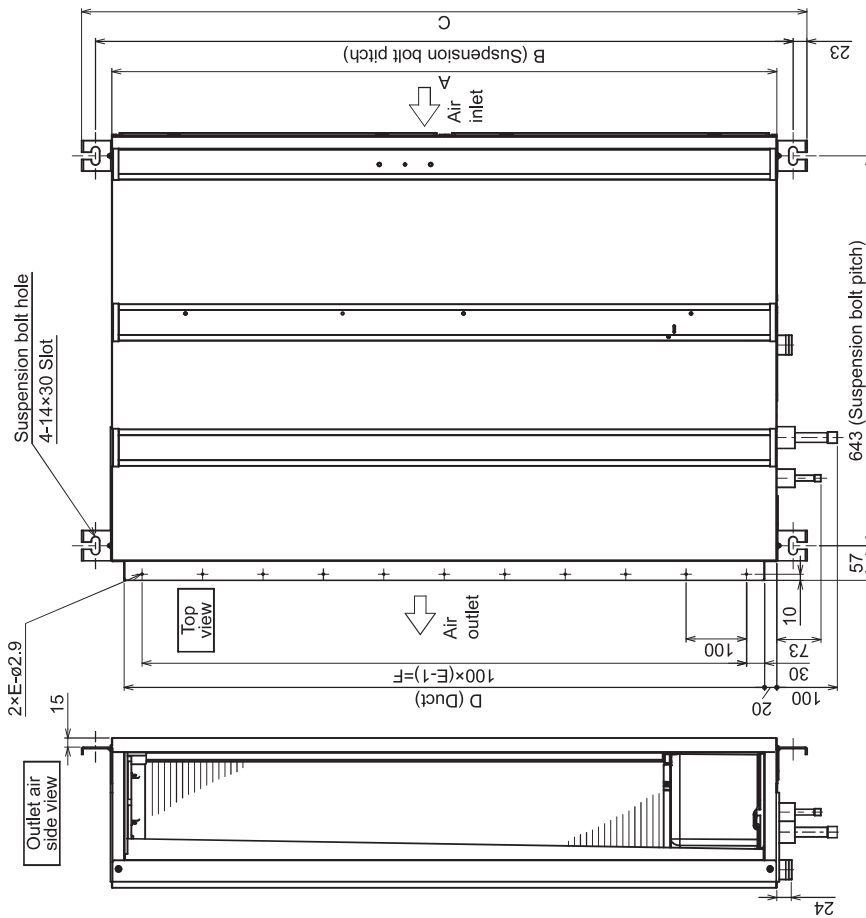

PEFY-M20, 25, 32, 40, 50, 63, 71, 80, 100, 125, 140VMAL-A

Unit: mm

[Maintenance access space]
 Secure enough access space to allow for the maintenance, inspection, and replacement of the motor, fan, heat exchanger, and control box in one of the following ways.
 Select an installation site for the indoor unit so that its maintenance access space will not be obstructed by beams or other objects.
 (1) When a space of 300mm or more is available below the unit between the unit and the ceiling, (Fig.1)
 · Create access door 1 and 2 (450×450mm each) as shown in Fig.2.
 (Access door 2 is not required if enough space is available below the unit for a maintenance worker to work in.)

(2) When a space of less than 300mm is available below the unit between the unit and the ceiling.
 (At least 20mm of space should be left below the unit as shown in Fig.3.)
 · Create access door 1 diagonally below the control box and access door 3 below the unit as shown in Fig.4.
 or
 · Create access door 4 below the control box and the unit as shown in Fig.5.

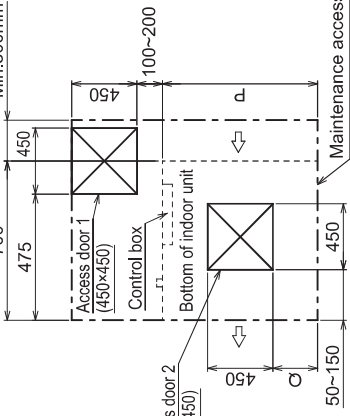
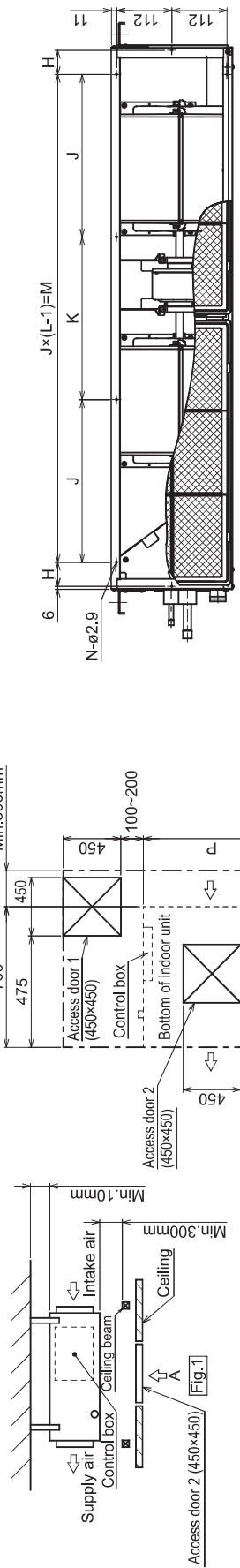

Fig.2 (Viewed from the direction of the arrow A)

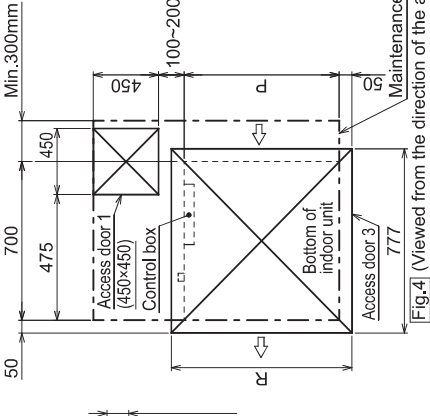

Fig.4 (Viewed from the direction of the arrow B)

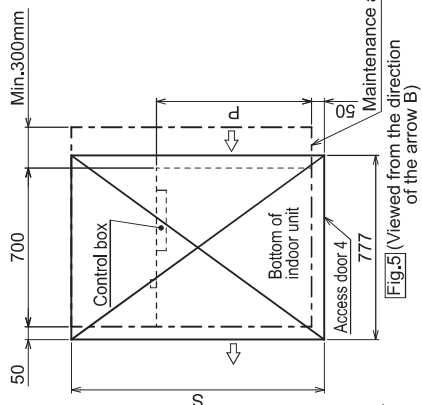

Fig.5 (Viewed from the direction of the arrow B)

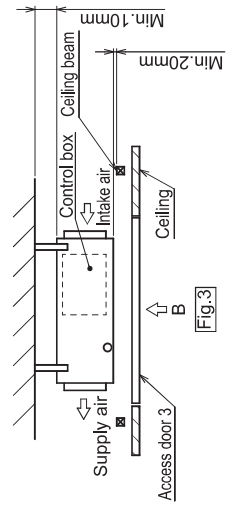

Fig.3

Model	H	J	K	L	M	N	P	Q	R	S
PEFY-M20, 25, 32VMAL-A	44	150	300	4	780	10	700	50~150	800	1300
PEFY-M40, 50, 63VMAL-A	54	260	4	990	10	900	150~250	1000	1500	1500
PEFY-M71, 80VMAL-A	49	330	4	1100	10	1100	250~350	1200	1700	1700
PEFY-M100, 125VMAL-A	54	320	5	1280	12	1400	400~500	1500	2000	2000
PEFY-M140VMAL-A	54	370	5	1480	12	1600	500~600	1700	2200	2200

PEFY-M-VMAL(L)-A

PEFY-M20, 25, 32, 40, 50, 63, 71, 80, 100, 125, 140VMAL-A Suction filter box built-in-specification

Unit: mm

- Note 1. Use M10 screw for the Suspension bolt (field supply).
 2. Keep the service space for the maintenance at the bottom.
 3. This chart indicates for PEFY-M71, 80VMAL-A models, which have 2 fans. PEFY-M20-25-32VMAL-A models have 1 fan. PEFY-M40-50-63VMAL-A models have 2 fans. PEFY-M100-125-140VMAL-A models have 3 fans.
 4. Use air filter installed with indoor unit.

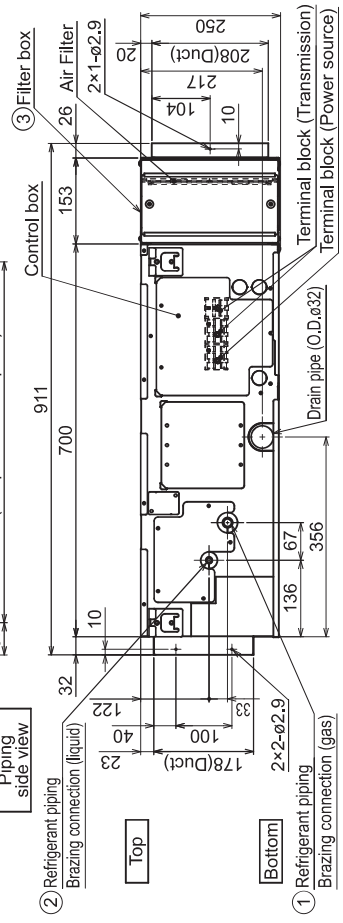
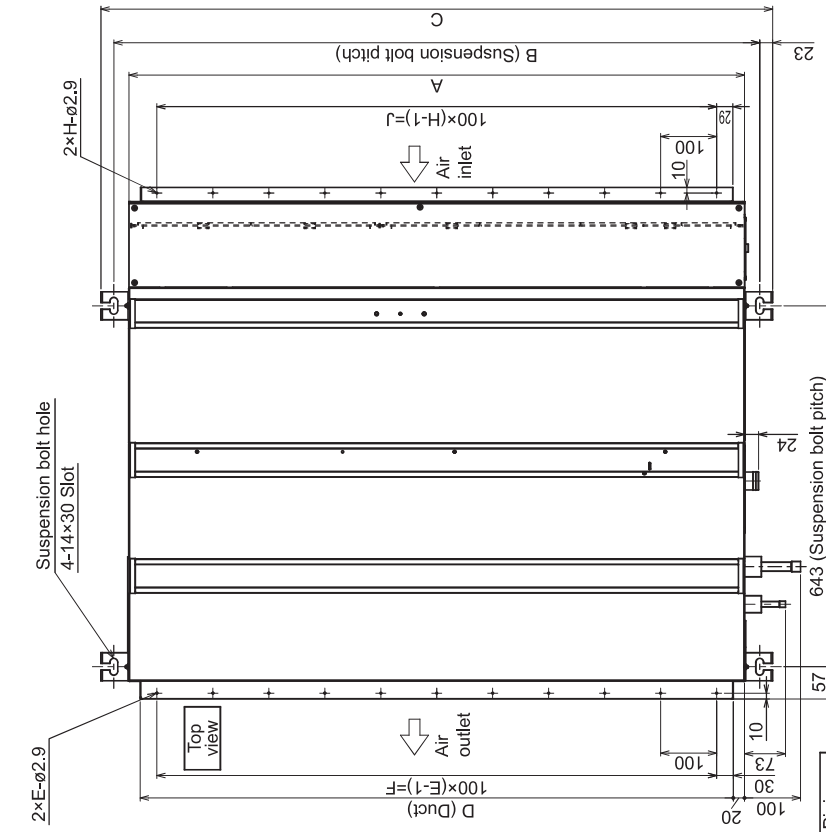
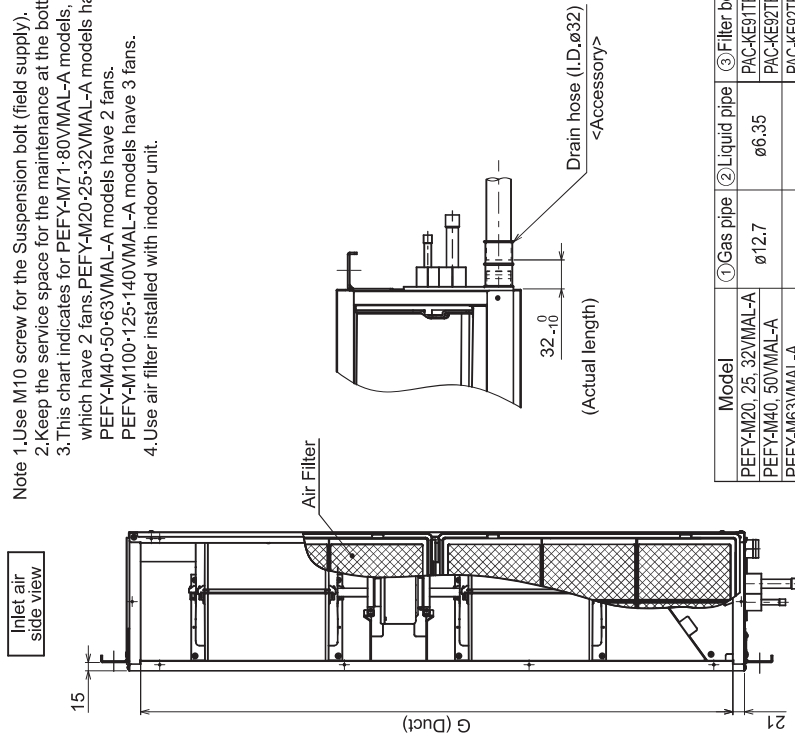

Model	① Gas pipe	② Liquid pipe	③ Filter box
PEFY-M20, 25, 32VMAL-A	ø12.7	ø6.35	PAC-KE91TB-E
PEFY-M40, 50VMAL-A			PAC-KE92TB-E
PEFY-M63VMAL-A	ø15.88	ø9.52	PAC-KE92TB-E
PEFY-M71, 80VMAL-A			PAC-KE93TB-E
PEFY-M100, 125VMAL-A			PAC-KE94TB-E
PEFY-M140VMAL-A			PAC-KE95TB-E

Model	A	B	C	D	E	F	G	H	J
PEFY-M20, 25, 32VMAL-A	700	754	800	660	7	600	658	7	600
PEFY-M40, 50, 63VMAL-A	900	954	1000	860	9	800	858	9	800
PEFY-M71, 80VMAL-A	1100	1154	1200	1060	11	1000	1058	11	1000
PEFY-M100, 125VMAL-A	1400	1454	1500	1360	14	1300	1358	14	1300
PEFY-M140VMAL-A	1600	1654	1700	1560	16	1500	1558	16	1500

<Suction filter box built-in-specification>

PEFY-M20, 25, 32, 40, 50, 63, 71, 80, 100, 125, 140VMAL-A Suction filter box built-in-specification

Unit: mm

[Maintenance access space]
Secure enough access space to allow for the maintenance, inspection, and replacement of the motor, fan, heat exchanger, and control box in one of the following ways.
Select an installation site for the indoor unit so that its maintenance access space will not be obstructed by beams or other objects.

- (1) When a space of 300mm or more is available below the unit between the unit and the ceiling. (Fig.1)
 - Create access door 1 and 2 (450×450mm each) as shown in Fig.2.
- (2) When a space of less than 300mm is available below the unit between the unit and the ceiling. (At least 20mm of space should be left below the unit as shown in Fig.3.)
 - Create access door 1 diagonally below the control box and access door 3 below the unit as shown in Fig.4.
 - or
 - Create access door 4 below the control box and the unit as shown in Fig.5.

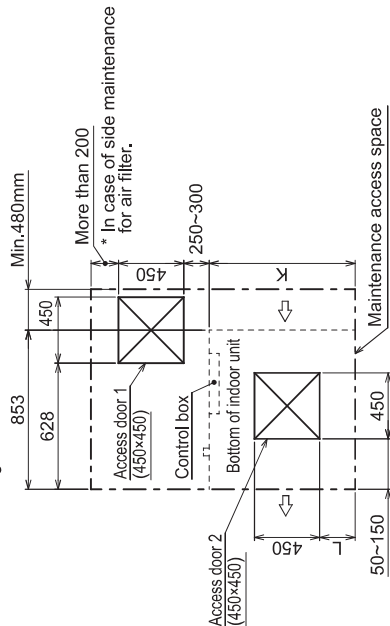
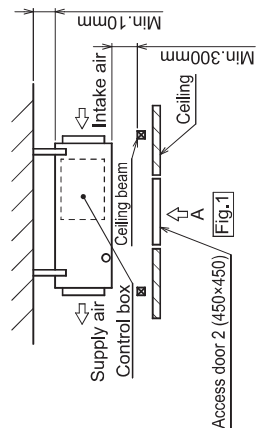

Fig.2 (Viewed from the direction of the arrow A)

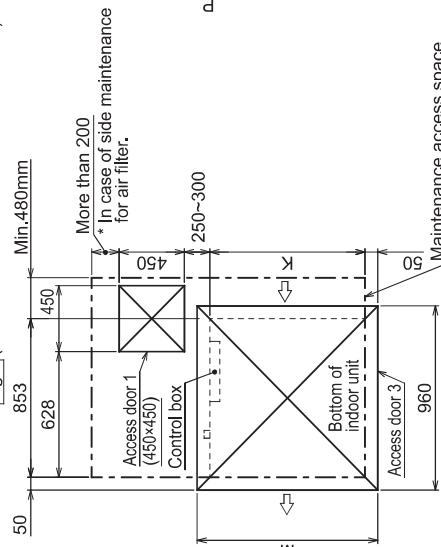

Fig.4 (Viewed from the direction of the arrow B)

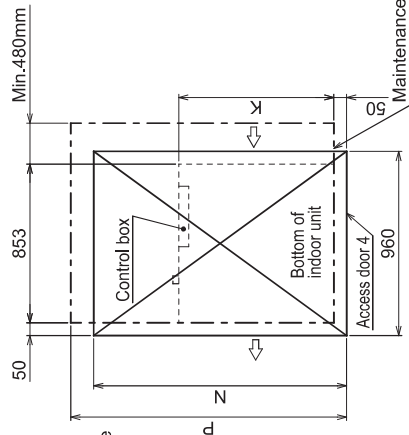

Fig.5 (Viewed from the direction of the arrow B) <Suction filter box built-in-specification>

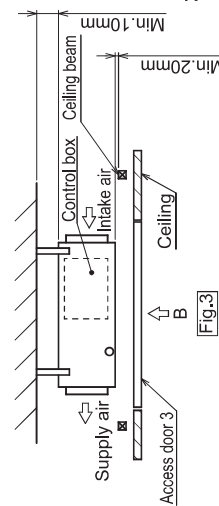

Fig.3

* Dimension 'P' is in case of side maintenance for air filter.

Model	K	L	M	N	P*
PEFY-M20, 25, 32VMAL-A	700	50~150	800	1300	1450
PEFY-M40, 50, 63VMAL-A	900	150~250	1000	1500	1850
PEFY-M71, 80VMAL-A	1100	250~350	1200	1700	2100
PEFY-M100, 125VMAL-A	1400	400~500	1500	2000	2150
PEFY-M140VMAL-A	1600	500~600	1700	2200	2550