



**MITSUBISHI  
ELECTRIC**

**MITSUBISHI ELECTRIC  
HYDRONICS & IT COOLING SYSTEMS S.p.A.**

MANUAL CODE:  
IUM\_WIZARDX\_03\_22\_EN

SAP CODE  
C010029464

# **WIZARDX/WIZARDX-G07**

## **Air-handling units**

**EN**

---

**INSTALLATION, USE AND MAINTENANCE MANUAL**

Italian is the original language. The other languages versions are translation of the original.

To ensure safe and correct use, carefully read this manual and make sure to understand all the contained indications and information.

---



**Before carrying out any operation on the machine,  
you must carefully read this manual and make sure  
you understand all the instructions and information given**

**Keep this manual in a known and easily accessible place  
to refer to as necessary during the entire life-span of the  
unit.**

This manual was prepared by MEHITS S.p.A.: reproduction, even in part, is prohibited.

The original copy is kept on file by MEHITS S.p.A.

Any use of the manual other than for personal reference requires the prior authorisation of MEHITS S.p.A.

In the interest of improving the quality of its products, MEHITS S.p.A. reserves the right to modify, without notice, the data and content of this Manual.

The information in this document may be modified without prior notice.

The reproduction and/or dissemination of this document, even in part, is prohibited without the written consent of MEHITS SpA.

# CONTENTS

<b>1</b>	<b>GENERAL PROVISIONS.....</b>	<b>7</b>
1.1	General information and safety .....	7
1.1.1	Scope of the manual .....	7
1.1.2	Glossary and terminology .....	7
1.1.3	Attached documentation .....	8
1.1.4	Safety regulations .....	8
1.1.4.1	Proper and improper use .....	10
1.1.5	Precautions against residual risks .....	11
1.1.6	Procedure for requesting support .....	13
1.2	Designation .....	14
1.3	<b>GENERAL DESCRIPTION .....</b>	<b>16</b>
1.3.1	General description .....	16
1.3.2	Unit configuration .....	16
1.3.3	Main machine components .....	17
1.3.4	Operating limits of the machines .....	20
1.3.5.1	Technical characteristics of machines with R410A refrigerant .....	20
1.3.5.2	Technical characteristics of machines with R32 refrigerant .....	21
1.3.6	Packaging of standard units .....	22
1.3.7	Information on the packaging .....	23
<b>2</b>	<b>TRANSPORT, STORAGE AND INSTALLATION .....</b>	<b>24</b>
2.1	Transport and handling instructions .....	24
2.1.1	Storage .....	24
2.1.2	Transport .....	25
2.1.3	Unloading and handling .....	25
2.1.4	Receipt and inspection of the equipment .....	26
2.1.5	Handling .....	29
2.2	Installation instructions .....	32
2.2.1	Installation of the standard machine .....	32
2.2.1.2	Minimum installation area for units with R32 .....	33
2.2.2	Machine positioning .....	35
2.2.3	Installation clearances .....	39
2.2.4	Connection of the cooling circuit between WIZARDX and Mr. Slim unit .....	41
2.2.5	Hydraulic connection .....	44
2.2.6	Hydraulic circuit sizing .....	44
2.2.7	Hydraulic circuit connection .....	45
2.2.8	Cleaning and filling the hydraulic circuits .....	46
2.2.9	Water quality .....	46
2.2.10	Sizing and connection of the cooling circuits .....	48
2.2.11	Compressor lubricant oil top up .....	48
2.2.12	Safety valves and position and provisions of the drain piping .....	48
2.2.13	Electrical connections .....	48
2.2.14	Air connections .....	52
2.2.15	Pressure drops on the air side of the ducts .....	54
2.2.16	Bms connection .....	54
<b>3</b>	<b>START-UP STAGES.....</b>	<b>54</b>
3.1	Before starting the unit .....	54
3.2	Machine start-up .....	58
3.2.1	Calibration and tuning procedures .....	58
3.2.2	Unit start-up .....	58
3.2.3	Adjustments and calibration .....	59
<b>4</b>	<b>USE AND MAINTENANCE.....</b>	<b>59</b>
4.1	Method of use .....	59
4.1.1	Description of controls .....	59
4.1.2.	Prolonged shutdowns of the machine .....	60
4.1.3	Start-up after extended machine inactivity .....	60
4.2	Maintenance instructions .....	61
4.2.1	General information .....	61
4.2.2	Scheduled maintenance .....	62
4.2.3	Table of general maintenance jobs .....	62

---

4.2.4	Extraordinary maintenance .....	67
<b>5</b>	<b>OPTIONALS .....</b>	<b>75</b>
<b>6</b>	<b>DISPOSAL OF THE UNIT.....</b>	<b>85</b>
<b>7</b>	<b>FIRST DIAGNOSTICS .....</b>	<b>85</b>
7.1	What to do if.....	85
72	Alarm Log .....	85

## SYMBOLS:

A number of symbols are used to highlight some parts of the text that are of particular importance. These are described below.

**CAUTION:**

Safety information that warns users about potential sources of damage or danger to the user and/or health and provides instructions on how to avoid them.

**OBLIGATION:**

Indicates that certain operations need to be carried out and/or appropriate behaviour adopted to ensure the safety of the user and third parties and/or correct operation of the unit.

**PROHIBITION:**

Prohibition to perform certain movements or activities.

**INFORMATION:**

Messages sent and received relating to news or notions considered useful or essential for the user.

# 1 GENERAL PROVISIONS

## 1.1 General information and safety

### 1.1.1 Scope of the manual

This manual, which is an integral part of the machine, has been produced by the manufacturer to provide the necessary information to all those who are authorized to interact with the machine during its intended life.

The authorised individuals are as follows:

- buyers;
- system designers;
- freight forwarders;
- logistics operators;
- installers;
- experienced operator;
- specialist technician;
- users.

As well as adopting a code of good practice, the recipients of the manual must read the information with care and apply it scrupulously. Taking a little time to read this information can help avoid risks to the health and safety of persons as well as prevent financial losses.

The information was written by the manufacturer in the manufacturer's native language (Italian) and is referred to as the "ORIGINAL INSTRUCTIONS". This information is also available in English as the "TRANSLATION OF THE ORIGINAL INSTRUCTIONS" and can be translated into other languages to meet legislative and/or commercial requirements. The information is valid even if the machine in your possession is not exactly the same as the one referred to.

Keep this manual in a known and easily accessible place to refer to as necessary.

The manufacturer reserves the right to modify the product without prior notice.

A number of symbols are used to highlight some parts of the text that are of particular importance. These are described below.

### 1.1.2 Glossary and terminology

There are some recurring terms in the manual which are described below in more detail.

**Hazard:** potential source of injury or damage to health.

**Risk:** combination of the probability and severity of an injury or health damage.

**Trained individual:** a person with levels of training, knowledge and experience that enable them to identify risks and avoid hazards.

**Residual risk:** risk that cannot be completely eliminated by the protective measures built in the machine.

**Protective device:** a device that reduces risks.

**Mehits:** Mitsubishi Electric Hydraulics & IT Cooling System S.p.A, also owner of the Climaveneta and RC brands.

**Buyer:** the person responsible for making the purchase who must supervise the organisation and assignment of duties to ensure that everything is done in compliance with the applicable laws.

**Enthalpy:** a function that can be defined as the sum of the internal energy and the product of pressure for the volume of fluid.

**Installer:** specialist competent person duly appointed and authorised to set up the machine or system according to the project specifications and the recommendations of the machine manufacturer and in compliance with the laws on safety at work.

**Maintenance person:** the person authorised by the owner to carry out on the unit all operations of regulation and checking expressly indicated in this manual, and which must be strictly followed. His/her work will be limited only to what is clearly allowed.

**Routine maintenance:** all the operations that help to ensure the good performance and efficiency of the machine. These operations are planned by the manufacturer who defines the skills required and the procedures to be implemented.

**Extraordinary maintenance:** all the operations that help to ensure the good performance and efficiency of the machine. These operations, which are not foreseeable, are not planned by the manufacturer and must only be carried out by the specialist technician.

**Logistics operators:** the persons who duly set up the machine and apply all the applicable measures so that it can be handled in a safe and correct manner. They are also those persons who, upon receipt of the machine, move it to the place of installation according to the instructions which can be found on the machine. All the above employees must have adequate skills and observe the instructions to ensure their own safety and that of those people with whom they interact in the process.

**Expert operator:** person appointed and authorised by the user or the buyer to use the machine and carry out the routine maintenance according to the instructions provided by the manufacturer. In the event of failures not considered in this manual, the expert operator must request the assistance of a specialist technician.

**Designer:** a competent specialist person duly appointed and authorised to draw up a project that takes into account all the legislative and regulatory aspects and code of good practice that apply to the system as a whole. In any case, as well as comply with the instructions provided by the machine manufacturer, the designer must **consider all the safety aspects for all those persons who will have to interact with the system during its expected life span.**

**Owner:** legal representative of the company, a body, or a natural person who owns the plant where the unit is installed and is responsible for checking compliance with all the safety rules in this manual and the national regulations in force.

**Specialist technician:** the person authorised directly by MEHITS to carry out all operations of ordinary and extraordinary maintenance. He/she will also carry out all regulations, checks, repairs and replacement of parts that should become necessary during the life of the unit itself. Outside Italy and those countries where MEHITS and its subsidiary are not directly present, the MEHITS agent is personally responsible for acquiring a suitable number of Technicians proportional to the area and to the business.

**Carriers:** the persons who take the machine to the destination in a suitable means of transport. They must stow and position the machine in a suitable way to ensure that it cannot move suddenly during transfer. When using devices for loading and unloading, they must observe the instructions that can be found on the machine to ensure their own safety and that of those people with whom they interact in the process.

**User:** person authorised to manage use of the machine in compliance with the "instructions for use" and the laws in force concerning safety at work.

**WIZARDX:** direct expansion air handling unit for use in conjunction with MR. Slim with R410A charge

**WIZARDX-G07:** direct expansion air handling unit for use in conjunction with MR. Slim with R32 charge

### 1.1.3 Attached documentation

The customer is provided with this documentation together with the machine:

- **Installation, use and maintenance manual:** it contains the list of operations to carry out.
- **Wiring diagram:** it is specific to the machine in question. It is useful for the persons who will have to carry out work on the electrical system, as it shows the various components and connections.
- **Dimensional and lifting drawings**
- **Assembly instructions for optional items:** they describe the procedures for their installation on the machine.
- **EC declaration of conformity:** indicates that the machines comply with current European directives.
- **Manual of the electronic controller**

Before any activities, make sure to have received all the documentation listed, which must be read carefully and fully understood.

### 1.1.4 Safety regulations

This product is a complex machine. During installation, operation, maintenance and repairs, people and objects might be exposed to risks associated with certain conditions or components such as, but not limited to: refrigerant, oils, moving mechanical parts, pressure, heat sources, electrical power. Each of these elements might result in damage to objects and possibly serious personal injury or even death. The people who operate the product have the obligation and responsibility to identify and recognise dangers and to protect themselves and always proceed in safety.



The unit must be installed in an area where access is only permitted to **OPERATORS, MAINTENANCE PERSONNEL and TECHNICIANS**. If this is not possible, it must be enclosed in a perimeter fence positioned at least two metres from the external surfaces of the machine itself.

The staff of the **INSTALLER** or any other visitors must always be accompanied by an **OPERATOR**. For no reason whatsoever must non-authorised persons be left on their own with the unit.

**MAINTENANCE TECHNICIANS** must only work on the controls of the unit. They should not open any panels, other than the access panel to the control module. The **INSTALLER** must limit him/herself to connecting the plant to the unit.

Access the unit using the relative personal protective equipment and only after having read and understood the documents and instructions, which must always be kept close at hand.

This product and the relative documents, including this manual, are intended for people who have received independent training and have been taught how to work in a correct and safe manner. Before handling this equipment in any way, it is essential that the personnel involved have read and understand all the manuals and all the other reference material. The personnel must also be familiar with and observe the standards that apply to the work in hand.

The manufacturer, during design and construction, has paid particular attention to aspects that may pose a risk to the safety and health of people interacting with the machine. The manufacturer has complied with the applicable laws as well as the code of good manufacturing practice. The purpose of this manual is to encourage users to take all due care and thereby avoid any risks. In any case, prudence is required at all times. Safety is also the responsibility of all operators who interact with the machine.

Carefully read the instructions in this manual and those applied directly on the machine, and respect those concerning safety in particular.

An overall project that envisages implementation of this machine in a system must take into account the code of good practice as well as the legislative and regulatory aspects. Particular attention must be paid to all the recommendations and technological information provided by the manufacturer. Do not tamper with, avoid, remove or bypass the safety devices installed on the machine. Failure to observe this requirement could result in serious risks to the health and safety of the persons involved.

The personnel who carry out any kind of work during the entire life span of the machine must have precise technical knowledge, special skills and recognised experience in the specific sector. Non-fulfilment of these requirements could endanger people's health and safety.

Keep the area around the machine in a good state in order to avoid risks to the health and safety of persons during normal use and maintenance of the machine.

Some processes may require the assistance of one or more helpers. In which case, these helpers must be duly trained and informed of the type of work to be carried out in order to avoid risks to their health and safety.

Move the machine observing the information shown on the packaging and the instructions on use provided by the manufacturer.

When handling, if the circumstances demand it, request the assistance of one or more helpers who can give directions.

The personnel who carry out loading, unloading and handling of the equipment must have recognised skills and experience in the specific sector and must have absolute command of the lifting equipment to be used.

During installation, observe the clearances indicated by the manufacturer and take into account all the work activities carried out in the vicinity. Installation must also be carried out in compliance with the laws in force on safety at work.

The machine must be installed and connected in accordance with the manufacturer's instructions. The person in charge must also take into account all regulatory and legislative requirements, carrying out all installation and connection operations in a workmanlike manner.

After installation and before commissioning the machine, he must perform a general check to make sure that these requirements have been met.

Check that any means of transport to be used for transfer of the machine are suitable for the purpose, and that the machine is loaded and unloaded with care to ensure the safety of the operator and of any other persons who are directly involved. Before transfer, make sure that the machine and its components are duly anchored to the vehicle and do not exceed the maximum permitted dimensions for transport on the vehicle. Apply any necessary signs.

The operator must have read and understood the information on use of the machine, and have suitable skills and experience for carrying out the work in hand.

Put the machine only to the uses foreseen by the manufacturer. Improper use of the machine may pose risks to the health and safety of the persons and cause financial losses.

The machine has been designed and constructed to meet all the operating conditions indicated by the manufacturer. Tampering with any of the devices to change the performance can expose the persons to health and safety risks and cause financial losses.

Only use the machine with the safety devices properly installed and in perfect working order. Failure to observe this requirement could result in serious risks to the health and safety of the persons involved.

Keep the machine in perfect working order and perform the routine maintenance recommended by the manufacturer. Good maintenance can help to ensure the best possible performance, a long useful life and constant compliance with the safety requirements.

Before maintenance and adjustments, activate all the applicable safety devices and provide the personnel and any other people in the vicinity with all necessary information.

In particular, cordon off the area and prevent access to all the devices that could, if activated, inadvertently cause danger and pose risks to health and safety.

Maintenance and adjustments must be carried out by authorised persons who must implement all the necessary safety measures according to the procedures set down by the manufacturer.

All maintenance operations that require specific technical expertise or skills must only be carried out by qualified personnel with recognised experience in the field.

In the case of maintenance in areas that are awkward or dangerous to access, implement appropriate measures to ensure the safety of oneself and of other people, in compliance with the laws in force on safety at work.

Replace excessively worn parts with original spare parts. Use components recommended by the manufacturer. All the above can help to ensure the good working order of the machine and the required level of safety.



**CAUTION:**

During regular maintenance activities or in the event of a fault only use original components.



**PROHIBITION:**

The user is strictly prohibited to perform activities such as commissioning, regular/extraordinary maintenance, modifications or anything else not provided for in this manual.

#### 1.1.4.1 Proper and improper use

Use the unit only for the intended purposes for which it was designed. Any other use relieves Mehits of all liability arising from improper use of the unit.

Air-handling units are designed for civil and industrial air handling.

In case of corrosive and/or explosive operating environments, during the design stage it is essential to make the machine suitable for handling particular flows.

The use of the unit must always and in all cases comply with the design parameters set during the contract negotiations in agreement with the customer. Any other use must be considered improper and dangerous.

Mehits shall not be liable for damage caused by different and unintended uses of the materials provided.

It is forbidden to use the unit:

- In explosive atmosphere
- In a flammable atmosphere
- In a corrosive atmosphere
- In excessively dusty environments
- By untrained personnel
- Not in accordance with current legislation
- If incorrectly installed
- With supply defects
- Without fully or partially following the instructions
- If not properly maintained and/or if non-original spare parts are installed
- With inefficient safety components.

### 1.1.5 Precautions against residual risks

#### Prevention of residual mechanical risks

- install the unit according to the instructions set out in this manual;
- regularly carry out all the maintenance operations foreseen in this manual;
- wear protective equipment (gloves, eye protection, hard hat, etc.) appropriate for the work being carried out. Do not wear clothing or accessories that can get entangled or sucked in by the air flow. Collect and tie hair to the head before entering the unit;
- before opening the machine panelling make sure that it is firmly hinged to the machine;
- the fins on heat exchangers and the edges of metal components and panels can cause cuts;
- do not remove the guards from mobile components while the unit is operating;
- make sure that mobile component guards are fitted correctly before restarting the unit;
- fans, motors and belt drives might be running. Before accessing these, always wait for them to stop and take appropriate measures to prevent them from starting up;
- fans, motors and belt drives might be running. Before starting the machine, make sure to install the appropriate protections to prevent contact with the components during operation;
- the surfaces of the machine and pipes can get very hot or cold and cause the risk of scalding;
- never exceed the maximum pressure limit (PS) of the water circuit of the unit indicated;
- before removing parts on the pressurised water circuits, close the section of the piping concerned and drain the fluid gradually to stabilise the pressure at the atmospheric level;
- do not use your hands to check possible coolant leaks.

#### Prevention of residual electrical risks

- the unit contains live parts that could cause serious injury or death. Only personnel trained in electrical hazards should work on electrical and electronic components, such as electrical panels, motors, wiring. Personnel must wear the appropriate personal protective equipment for the activities at all times, including, for example, gloves, dielectric shoes and face shield, and use dielectric tools;
- before opening the electrical panel and any other electrical and electronic components, disconnect the unit from the mains using the external switch on the machine;
- in the electrical panel are some cables and terminals, indicated in orange, that remain powered even with the power disconnect open (circuits excluded).
- check that the unit has been grounded correctly before starting it;
- the machine must be installed in a suitable place. Do not install the machine outdoors if it is intended for indoor use;
- do not use cables of inadequate cross-section or loose connections. Not even in an emergency, or for limited periods;
- for units with power correction capacitors, wait 3 minutes after removing the electric power supply before accessing the inside of the electrical panel;
- if the unit is equipped with frequency converters (inverters), disconnect the power supply and wait at least 15 minutes before accessing it to carry out maintenance. During this time, internal components remain live, creating a risk of electric shock.

#### Prevention of environmental risks

- The machine contains substances and components that are dangerous for the environment, such as refrigerant gases and lubricant.
- The units may only be serviced and disposed of by qualified technicians.

#### Refrigerant gas:

The cooling circuit contains fluorinated greenhouse gases covered by the Kyoto Protocol.

The fluorinated greenhouse gases contained in the cooling circuit must not be disposed of in the atmosphere.

Refrigerant gases must be recovered in accordance with current laws.

Coolant	R410A	R32
GWP100	2088	675

#### Lubricant oil:

The cooling compressors and the cooling circuit contain lubricant oil.

The oil must be recovered in accordance with current laws.

Do not disperse the oil in the environment.





























**For the level of machine noise emissions refer to the Technical Data Sheet of the unit. For the PPE required and any operations/components for the reduction of noise see the table.**

## Prevention of other residual risks

- When using R32 refrigerant, it will be necessary to take into account its LFL (Low Flammable Level), equal to 0.307 kg/m<sup>3</sup>. To reduce the risk of flame, avoid areas with a gas concentration greater than 0.077 kg/m<sup>3</sup> (25% LFL).
- To ensure safety with units charged with R32 refrigerant, make sure to observe the minimum area constraints for installation as outlined in Section 2.2.1.2.
- Units using R32 refrigerant may only be installed outdoors.
- In order to ensure adequate ventilation to units with R32 charge, it is important that ducts are as indicated in chapter 2.2.14, making sure that the inverted operation vane of the delivery damper is excluded from the aerodynamic duct.
- The unit contains pressurized refrigerant gas. The pressurized equipment must not be touched except during maintenance, which must be entrusted to qualified and authorized personnel.
- Connect up the utilities to the unit following the indications set out in this manual and in the pictograms on the paneling of the unit itself.
- The water circuit contains harmful and bio-hazardous substances (e.g. legionella). Do not drink from the hydraulic circuit and make sure the material contained in it does not touch your skin, eyes or clothing.
- In order to avoid an environmental risk, make sure that any leaking fluid is collected in suitable devices in accordance with local regulations.
- If a part needs to be dismantled, make sure it is correctly re-assembled before starting the unit.
- When the rules in force require the installation of fire-fighting systems near the machine, check that these are suitable for extinguishing fires on electrical equipment, and in the presence of compressor lubricant oil or refrigerant. As indicated in the material safety data sheets of these fluids (for example a CO<sub>2</sub> extinguisher).
- If the unit is equipped with overpressure release devices (safety valves), if these devices are activated, the refrigerant gas is released at high temperature/speed. Prevent the jet of gas released from injuring people or damaging property. If necessary, channel the discharges appropriately, according to the provisions of the EN 378-3 standard and the current local regulations in force, making sure to discharge to open and safe places any fluids belonging to a safety group other than A1 (see table 3).
- Keep all the safety devices in good working order and check them periodically according to the regulations in force.
- Keep all lubricants in suitably marked containers.
- Do not store inflammable liquids near the unit.
- Only carry out brazing or welding activities on clean and empty pipes, without lubricant oil residues. Do not bring flames or other sources of heat near pipes containing refrigerating liquid.
- Do not use naked flames near the unit.
- The machinery must be installed in structures protected against atmospheric discharge according to the applicable laws and technical standards.
- Do not bend or hit pipes containing pressurized fluids.
- It is not permitted to walk or rest other objects on the machines.
- The user is responsible for overall evaluation of the risk of fire in the place of installation (for example, calculation of the fire load).
- During transport, always secure the unit to the bed of the vehicle to prevent it from moving about and overturning.
- The machine must be transported according to the regulations in force taking into account the characteristics of the fluids in the machine and the description of these on the safety data sheet.
- Inappropriate transport can cause damage to the machine and leaking of the cooling fluid. Before start-up, the machine must be checked for leaks and repaired accordingly.
- The accidental release of refrigerant in an enclosed area can cause lack of oxygen, and therefore a risk of asphyxiation. Install the machine in a suitably ventilated area, in accordance with the EN 378-3 standard and local regulations.
- The installation must comply with the requirements of EN 378-3 and the local regulations in force; in the case of installations indoors, good ventilation must be guaranteed and refrigerant detectors must be fitted when necessary.
- Unless arranged otherwise with MEHITS, the machine be installed in environments where there is no risk of explosion (SAFE AREA).
- The structure of the unit is not designed to withstand the stresses (accelerations) caused by an earthquake.

In accordance with the standard EN 60204-1, the handle of the circuit breaker must be easy to access and at a height of between 0.6 and 1.9 metres above the floor.

The positioning of the machine in the place of installation must be considered, as if the unit is placed on a raised platform, the height of the switch might no longer be in compliance with the standards. In which case the installer must arrange for a walkway or a similar solution that can allow operators to access the safety device with ease.

Residual risks	Mandatory personal protective equipment						
Residual mechanical risks							
Residual electrical risks							
Other residual risks							
Residual risks for maintenance							

As far as the required PPE and its use, reference should be made to Italian Legislative Decree. 81/08 and IEC 82078-1:2012

### Safety signs

The unit is fitted with the necessary safety signs; here are some examples:



#### 1.1.6 Procedure for requesting support

For support, please contact one of the authorised centres (Italy) or our distributors (outside Italy). When requesting technical support concerning the machine, cite the data on the identification plate, and the serial number in particular, and describe the conditions of access and the area around the machine.

In your request, indicate the approximate hours of use and the fault detected. In case of alarm, indicate the alarm message number.

## 1.2 Designation

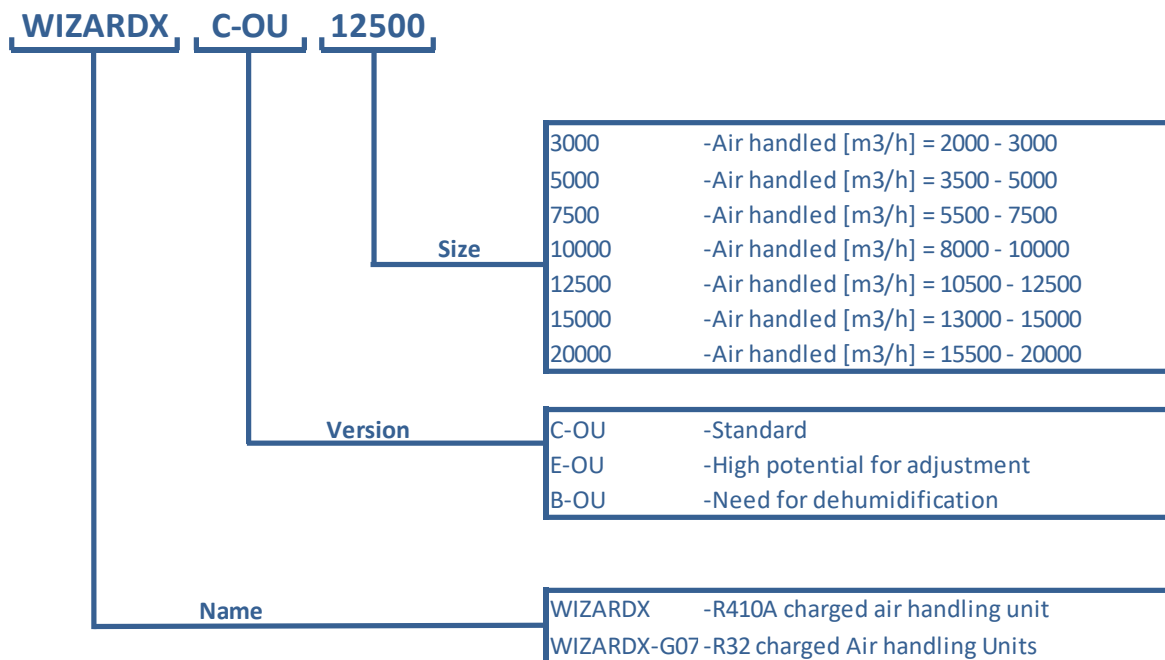

The type of machine is indicated on the label on the machine itself, normally on the inspection door of the delivery fan. The label provides the reference data and all the essential information required to ensure safe operation.

Type	<input type="text"/>	Mod.	Modello
Item	<input type="text"/>		Articolo
Serial number	<input type="text"/>		Matricola unità
Manufact. year	<input type="text"/>		Anno di costruz.
Operating weight	<input type="text" value="Kg"/>		Peso in funzionamento
<b>ELECTRICAL SUPPLY</b>			
Voltage	<input type="text"/>		
F.L.I.	<input type="text"/>		kW
F.L.A.	<input type="text"/>		A
<b>WATER SUPPLY</b>			
Pre-heating	<input type="text" value="m&lt;sup&gt;3&lt;/sup&gt;/h"/>	<input type="text" value="kPa"/>	Pre-risc.
Cooling	<input type="text" value="m&lt;sup&gt;3&lt;/sup&gt;/h"/>	<input type="text" value="kPa"/>	Raffr.
Post-heating	<input type="text" value="m&lt;sup&gt;3&lt;/sup&gt;/h"/>	<input type="text" value="kPa"/>	Post-risc.
Humidification	<input type="text" value="m&lt;sup&gt;3&lt;/sup&gt;/h"/>	<input type="text" value="kPa"/>	Umidif.
<b>SUPPLY / RETURN AIR FLOW DATA</b>			
Supply	<input type="text" value="m&lt;sup&gt;3&lt;/sup&gt;/h"/>	<input type="text" value="Pa"/>	Mandata
Motor	<input type="text" value="kW"/>	<input type="text" value="V"/>	Motore
	<input type="text" value="A"/>		
Return	<input type="text" value="m&lt;sup&gt;3&lt;/sup&gt;/h"/>	<input type="text" value="Pa"/>	Ripresa
Motor	<input type="text" value="kW"/>	<input type="text" value="V"/>	Motore
	<input type="text" value="A"/>		
Manual n°			<b>CE</b>
Wiring Diagrams:		rev.	
<b>MITSUBISHI ELECTRIC HYDRONICS &amp; IT COOLING SYSTEMS S.p.A.</b>			
Via Sarson 57/C			
36061 Bassano del Grappa (VI) Italy			
T: +39 0424 509500 - F: +39 0424 509509			
<a href="http://www.climaveneta.com">www.climaveneta.com</a>			
			

## 1.3 GENERAL DESCRIPTION

### 1.3.1 General description

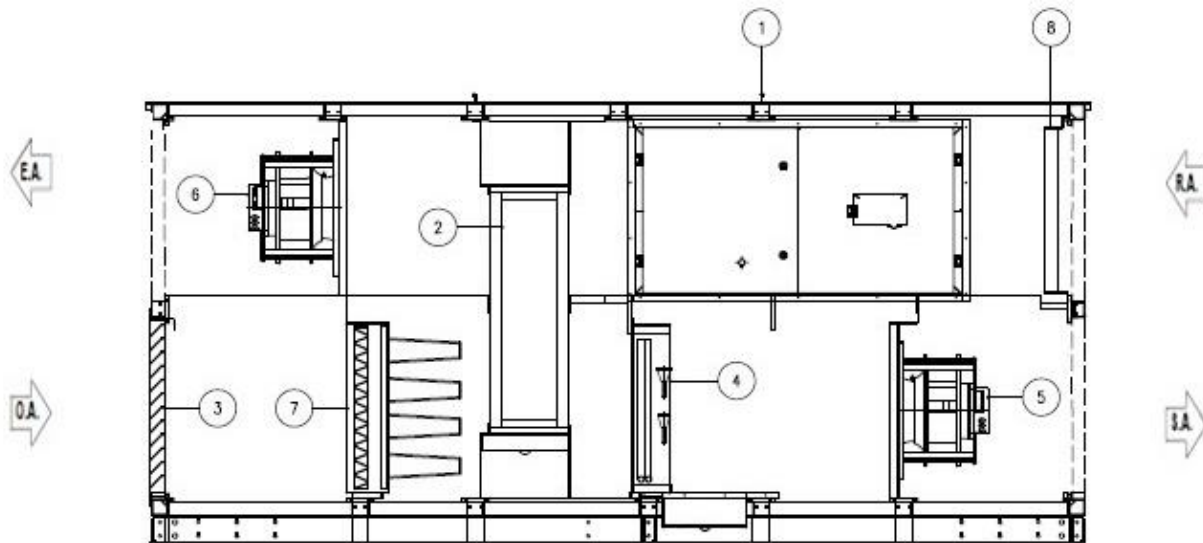

#### DESCRIPTION:

E.A. → Ejection flow

O.A. → External air flow

S.A. → Ambient delivery flow

R.A. → Ambient return flow

1 → Aluminium cover

2 → Rotary recovery

3 → Grid with anti-intrusion net

4 → ED Coil

5 → Delivery fan

6 → Return fan

7 → Delivery filters

8 → Return filters

The units in the WIZARDX series control the external air intake and are characterised by exceptional energy efficiency and a high level of configurability.

The WIZARDX units have a rotary heat recovery system and energy efficient fans selected in accordance with the European Ecodesign regulation 1253/2014 and are therefore compliant with the ErP 2018 directive.

The WIZARDX series is based on efficient direct expansion technology, where ecological R410A - R32 refrigerants are supplied to the internal coil, in combination with Mitsubishi Mr. Slim outdoor heat pump units.

The electrical power and control panel includes a microprocessor with preloaded exclusive management software that integrates all the characteristic functions of the machine. The panel provides for the integration of one or more Mitsubishi PAC-IF 013 electronic boards, which allow communication to and from Mr. Slim Mitsubishi outdoor units, to ensure their operation always at maximum efficiency.



#### CAUTION:

The guarantee is rendered null and void when:

- The instructions in this manual are not observed.
- The customer or a third party makes alterations to the unit without the consent of Mehtis.
- Losses or damage to people or things due to improper use of the equipment.

### 1.3.2 Unit configuration

There are three versions for specific weather conditions and applications:

- **Version C-OU (STANDARD):** version for air renewal only, with handling under conditions of neutral inlet temperature. Control of delivery temperature, optional control of return temperature.
- **Version B-OU (HIGH DEHUMIDIFICATION):** version for air renewal, with increased potential to permit better dehumidification. Control of delivery temperature, optional control of return temperature.
- **Version E-OU:** version for air renewal only, with handling under conditions of neutral inlet temperature with a direct expansion coil with more than one circuit and Mitsubishi Mr. Slim outdoor units for temperate climates. Control of delivery temperature, optional control of return temperature.



### Combination of WIZARDX units and Mr. Slim outdoor units

The units in the WIZARDX series are combined with the Mr. Slim direct expansion outdoor units to guarantee the required performance in both heating and cooling mode. The Mr. Slim outdoor units are combined with the three versions of the WIZARDX as shown in the tables below:

- Combinations for the **C-OU (STANDARD)** version of the WIZARDX

Outdoor Units	WIZARDX 3000	WIZARDX 5000	WIZARDX 7500	WIZARDX 10000	WIZARDX 12500	WIZARDX 15000	WIZARDX 20000
Size P50							
Size P100	1						
Size P125							
Size P140							
Size P200		1		2	1		
Size P250			1		1	2	3

- Combinations for the **E-OU** version of the WIZARDX

Outdoor Units	WIZARDX 3000	WIZARDX 5000	WIZARDX 7500	WIZARDX 10000	WIZARDX 12500	WIZARDX 15000	WIZARDX 20000
Size P50	2						
Size P100		2					
Size P125			2				
Size P140					3		
Size P200				2			
Size P250						2	3

- Combinations for the **B-OU (HIGH DEHUMIDIFICATION)** version of the WIZARDX

Outdoor Units	WIZARDX 3000	WIZARDX 5000	WIZARDX 7500	WIZARDX 10000	WIZARDX 12500	WIZARDX 15000	WIZARDX 20000
Size P50							
Size P100	2						
Size P125							
Size P140		1					
Size P200		1		3	4		
Size P250			2			4	5

### 1.3.3 Main machine components

#### Frame

Frame in double chamber aluminium profiles and panels fixed with flat-head screws that do not protrude into the unit. The screws are set in plastic to lessen the effect of the thermal bridge.

If the self-drilling screws that secure the panels to the frame are removed, they must be replaced with metric screws and their insert attached to the frame.

The units up to size 12.500 are one-piece, the size 15.000 is in 3 sections and size 20.000 is in 6 sections for the purpose of transport.

#### Panelling

The panels are of the double-walled sandwich type, with internal galvanized steel sheet thickness 5/10. The external sheet is in pre-plasticized galvanized steel thickness 5/10 for WIZARDX, and in pre-painted galvanized steel thickness 5/10 for WIZARDX-G07.

The panel is 45 mm thick with insulation made by means of the thermal expansion of polyurethane foam of a density of 45 kg/m<sup>3</sup>. The leakage class is L3 according to EN 1886 which defines a max leakage of 1.32 l/s\*m<sup>2</sup> with test pressure of -400 Pa and a leakage value of 1.90 l/s\*m<sup>2</sup> with test pressure +700 Pa.

The acoustic dampening properties of the panelling are shown in the table below:

Octave band Hz	125	250	500	1000	2000	4000	8000
Decibel reduction	10	12	14	15	21	34	38

The standard machine configuration is with inspection points (panels and opening doors) and refrigerant and water connections on the right. As optional, it is also possible to request the configuration with left connections and inspection points. The right and left sides are seen looking away from the flow of supply air.

- Inspection doors and refrigerant and water connectors on right side:

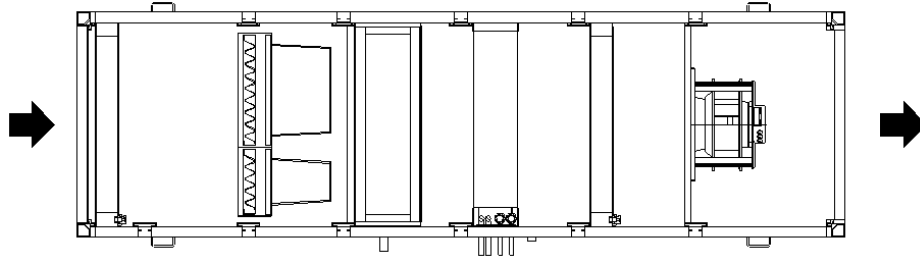

- Inspection doors and refrigerant and water connectors on left side:

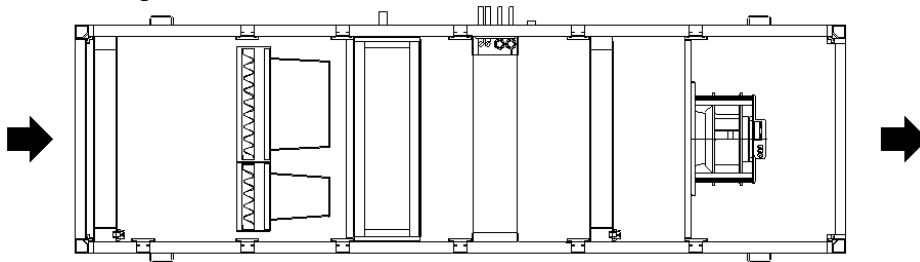

### Heat recovery unit

High performance rotary heat recovery unit to allow for efficient and high recovery of energy in compliance with ERP 2018 requirements.

The rotor is made of a special hygroscopic aluminium that guarantees high performance exploiting the latent contribution to the total recovery of the machine, making use therefore of the exchange of both humidity and sensitive heat.

### Direct expansion coil

- geometry 25 X 21.65 mm;
- copper pipe Ø 9.52 mm;
- copper manifolds;
- aluminium fins;
- galvanised steel frame;
- R410A or R32 ecological refrigerant.

### Switchboard and regulation

The functional heart of the WIZARDX is the switchboard with electronic controller and high-level components.

The microprocessor manages all the control and regulation functions of the WIZARDX and its optional accessories as well as the safety functions of the system.

The components used for regulation are temperature and humidity probes to detect the operating parameters of the unit, differential pressure switches on the filters to check the state of cleanliness, pressure transducers to check and manage the air flow of the fans, and all the components required for any additional accessories.

The B-OU and E-OU versions, which require more than one Mitsubishi Mr. Slim outdoor unit, are based on the exclusive Mitsubishi IMOUC protocol (Intelligent Multiple Outdoor Units Control) which optimises power levels and increases energy efficiency. In heating mode, the protocol manages the defrost phases of the outdoor units in sequential order with the aim of maintaining the required temperature setpoint with control of both the delivery and return temperature.

The units include specific power supplies and protections when ordering optional accessories that for their operation require adequate power consumption. In particular, if the steam generator or the electric pre and post heating coils are ordered, the power supply and the corresponding protection will be directly integrated in the electrical cabinet at the factory.

For accessories that must be installed separate from the base unit, specific connection cables with connectors are supplied. On-site connection using these connectors re-establishes the power and signal line between the main electrical panel and the external accessory.

## Fans

The delivery and return fans are centrifugal reverse-blade plug-fans with a free impeller and an electronically controlled high performance motor commonly called an EC motor. The motor is directly integrated into the fan structure for greater structural compactness and the ZAmid high performance composite material of the impeller and the low consumption of the electronically controlled motor allow for the best in ventilation performance.

## Air filter

In its standard configuration, the machine is supplied with ISO COARSE 55% - ISO 16890 (G4 - EN 779:2012) synthetic filters + EPM1 50% - ISO 16890 (F7 - EN 779:2012) rigid bag filters on the delivery line, and ISO COARSE 55% - ISO 16890 (G4 - EN 779:2012) synthetic filters on the return line.

## Cover panel

The cover is made as our standard in aluminum sheet and is always supplied as standard equipment for the WIZARDX-G07 units (outdoor installation). Other materials can also be used (galvanised steel - AISI 304). When the cover panel is fitted, the size of the unit is increased by 20 mm on each side and the height of the module it is fitted on is increased by 35 mm.

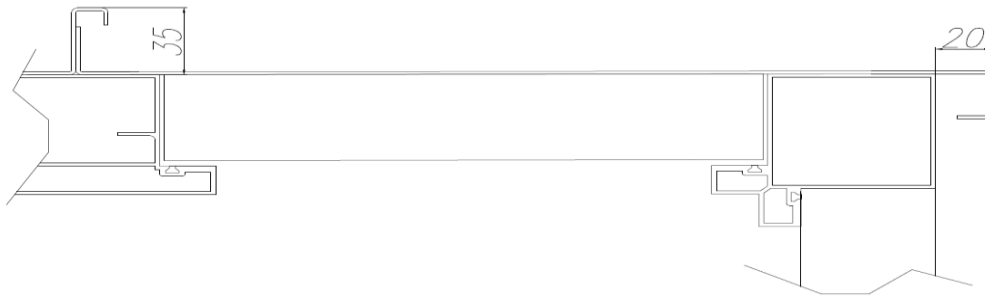

In some cases, the cover panel can be supplied disassembled on pallets or inside the unit and then fixed to the module using the screws supplied. If the self-drilling screws that secure the roof are removed, they must be replaced with metric screws and their insert attached to the frame.

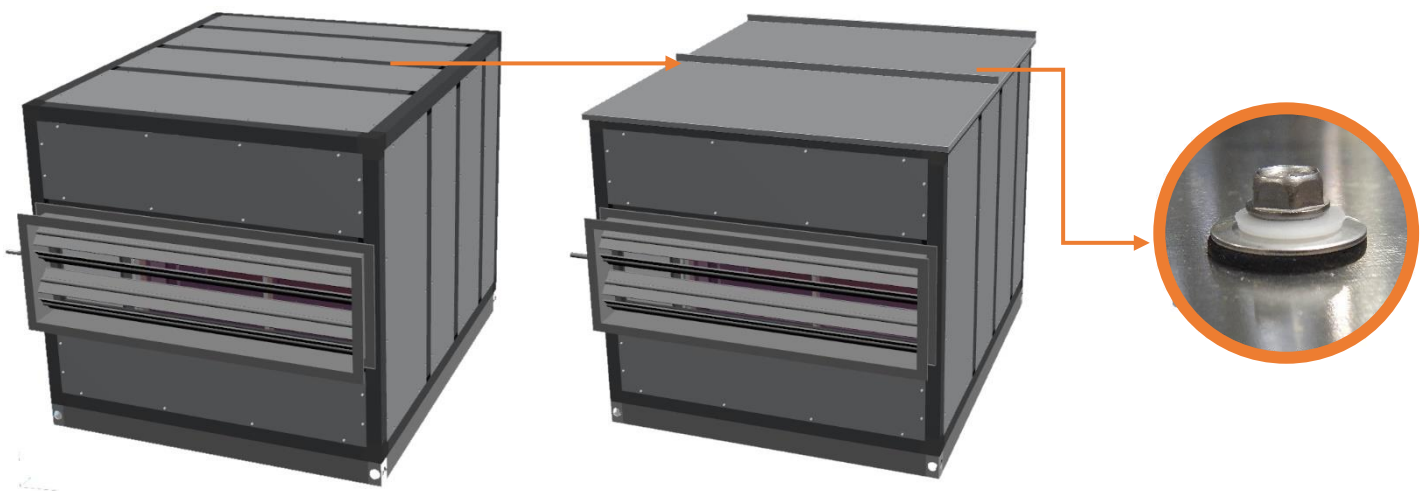

### 1.3.4 Operating limits of the machines



#### INFORMATION:

The operating range of the WIZARDX units is as follows (values referring to the temperature of the flow of fresh air entering the WIZARDX):

- Minimum temperature: -15 °C
- Maximum temperature: 40 °C

The preheating coil must be used for temperatures below -10 °C.

Check the operating range of the Mr. Slim condensing units in their documentation.

### 1.3.5 Technical characteristics of the machines

#### 1.3.5.1 Technical characteristics of machines with R410A refrigerant

		C-OU							
MODEL		WIZARDX 3000	WIZARDX 5000	WIZARDX 7500	WIZARDX 10000	WIZARDX 12500	WIZARDX 15000	WIZARDX 20000	
Air flow	[m <sup>3</sup> /h]	3000	5000	7500	10000	12500	15000	20000	
Air flow range	[m <sup>3</sup> /h]	2000 - 3000	3500-5000	5500-7500	8000-10000	10500-12500	13000-15000	15500 - 20000	
Max useful head (standard configuration)	[Pa]	250							
Max useful head (high pressure configuration)	[Pa]	400							
Cooling	Output of RH coil	[kW]	10	20	25	40	45	50	75
	Output of Heat recovery unit	[kW]	18,1	29,5	43,5	58,2	73,7	86,4	121,3
	Total output	[kW]	28,1	49,5	68,5	98,2	118,7	136,4	196,3
Heating	Output of RH coil	[kW]	11,2	22,4	27	44,8	49,4	54	81
	Output of Heat recovery unit	[kW]	13,8	22,2	32,8	43,9	55,5	65,4	92,4
	Total output	[kW]	25	44,6	59,8	88,7	104,9	119,4	173,4
Cooling	Sensitive heat recovery performance	[%]	75,4	72,7	71,7	72	72,7	71,4	75,6
	Total heat recovery performance	[%]	71,6	70	68,5	69,7	70	68,5	71,6
Heating	Sensitive heat recovery performance	[%]	77,1	74,3	73,4	73,6	74,3	73,1	77,2
	Total heat recovery performance	[%]	75,6	73,5	71,5	72,6	73,5	71,7	75,6
Power consumption (NOMINAL/MAX)	Delivery fan(s) (250Pa)	[kW]	0.85 / 2.5	1.39 / 2.5	1.87 / 5	2.51 / 5	3.18 / 5	3.88 / 10	5.53 / 10
	Return fan(s) (250Pa)	[kW]	0.74 / 2.5	1.25 / 2.5	1.61 / 5	2.16 / 5	2.91 / 5	3.35 / 10	4.80 / 10
	Rotary heat recuperator	[kW]	0,04	0,09	0,18	0,18	0,37	0,37	0,37
	Transformers	[kW]	0,7	0,7	0,7	0,7	1	1	1
	Total of WIZARDX	[kW]	2.33 / 5.74	3.43 / 5.79	4.36 / 10.88	5.55 / 10.88	7.46 / 11.37	8.60 / 21.37	11.70 / 21.37
Filtering section		F7 bag filters							
Humidification section (accessory)	[kg/h]	8	15	18	25	35	45	65	

All the data were obtained under nominal conditions, using a unit without accessories and with clean filters.

		E-OU							
MODEL		WIZARDX 3000	WIZARDX 5000	WIZARDX 7500	WIZARDX 10000	WIZARDX 12500	WIZARDX 15000	WIZARDX 20000	
Air flow	[m <sup>3</sup> /h]	3000	5000	7500	10000	12500	15000	20000	
Air flow range	[m <sup>3</sup> /h]	2000 - 3000	3500-5000	5500-7500	8000-10000	10500-12500	13000-15000	15500 - 20000	
Max useful head (standard configuration)	[Pa]	250							
Max useful head (high pressure configuration)	[Pa]	400							
Cooling	Output of RH coil	[kW]	10	20	25	40	42	50	75
	Output of Heat recovery unit	[kW]	18,1	29,5	43,5	58,2	73,7	86,4	121,3
	Total output	[kW]	28,1	49,5	68,5	98,2	115,7	136,4	196,3
Heating	Output of RH coil	[kW]	12	22,4	28	44,8	48	54	81
	Output of Heat recovery unit	[kW]	13,8	22,2	32,8	43,9	55,5	65,4	92,4
	Total output	[kW]	25,8	44,6	60,8	88,7	103,5	119,4	173,4
Cooling	Sensitive heat recovery performance	[%]	75,4	72,7	71,7	72	72,7	71,4	75,6
	Total heat recovery performance	[%]	71,6	70	68,5	69,7	70	68,5	71,6
Heating	Sensitive heat recovery performance	[%]	77,1	74,3	73,4	73,6	74,3	73,1	77,2
	Total heat recovery performance	[%]	75,6	73,5	71,5	72,6	73,5	71,7	75,6
Power consumption (NOMINAL/MAX)	Delivery fan(s) (250Pa)	[kW]	0.85 / 2.5	1.39 / 2.5	1.87 / 5	2.51 / 5	3.18 / 5	3.88 / 10	5.53 / 10
	Return fan(s) (250Pa)	[kW]	0.74 / 2.5	1.25 / 2.5	1.61 / 5	2.16 / 5	2.91 / 5	3.35 / 10	4.80 / 10
	Rotary heat recuperator	[kW]	0,04	0,09	0,18	0,18	0,37	0,37	0,37
	Transformers	[kW]	0,7	0,7	0,7	0,7	1	1	1
	Total of WIZARDX	[kW]	2.33 / 5.74	3.43 / 5.79	4.36 / 10.88	5.55 / 10.88	7.46 / 11.37	8.60 / 21.37	11.70 / 21.37
Filtering section		F7 bag filters							
Humidification section (accessory)	[kg/h]	8	15	18	25	35	45	65	

All the data were obtained under nominal conditions, using a unit without accessories and with clean filters.

		B-OU							
MODEL		WIZARDX 3000	WIZARDX 5000	WIZARDX 7500	WIZARDX 10000	WIZARDX 12500	WIZARDX 15000	WIZARDX 20000	
Air flow	[m <sup>3</sup> /h]	3000	5000	7500	10000	12500	15000	20000	
Air flow range	[m <sup>3</sup> /h]	2000 - 3000	3500-5000	5500-7500	8000-10000	10500-12500	13000-15000	15500 - 20000	
Max useful head (standard configuration)	[Pa]	250							
Max useful head (high pressure configuration)	[Pa]	400							
Cooling	Output of RH coil	[kW]	20	34	50	60	80	100	125
	Output of Heat recovery unit	[kW]	18,1	29,5	43,5	58,2	73,7	86,4	121,3
	Total output	[kW]	38,1	63,5	93,5	118,2	153,7	186,4	246,3
Heating	Output of RH coil	[kW]	22,4	38,4	54	67,2	89,6	108	135
	Output of Heat recovery unit	[kW]	13,8	22,2	32,8	43,9	55,5	65,4	92,4
	Total output	[kW]	36,2	60,6	86,8	111,1	145,1	173,4	227,4
Cooling	Sensitive heat recovery performance	[%]	75,4	72,7	71,7	72	72,7	71,4	75,6
	Total heat recovery performance	[%]	71,6	70	68,5	69,7	70	68,5	71,6
Heating	Sensitive heat recovery performance	[%]	77,1	74,3	73,4	73,6	74,3	73,1	77,2
	Total heat recovery performance	[%]	75,6	73,5	71,5	72,6	73,5	71,7	75,6
Power consumption (NOMINAL/MAX)	Delivery fan(s) (250Pa)	[kW]	0.89 / 2.5	1.44 / 2.5	1.97 / 5	2.70 / 5	3.35 / 5	4.10 / 10	5.79 / 10
	Return fan(s) (250Pa)	[kW]	0.74 / 2.5	1.25 / 2.5	1.61 / 5	2.16 / 5	2.91 / 5	3.35 / 10	4.80 / 10
	Rotary heat recuperator	[kW]	0,04	0,09	0,18	0,18	0,37	0,37	0,37
	Transformers	[kW]	0,7	0,7	0,7	0,7	1	1	1
	Total of WIZARDX	[kW]	2.37 / 5.74	3.48 / 5.79	4.46 / 10.88	5.74 / 10.88	7.63 / 11.37	8.82 / 21.37	11.96 / 21.37
Filtering section		F7 bag filters							
Humidification section (accessory)	[kg/h]	8	15	18	25	35	45	65	

All the data were obtained under nominal conditions, using a unit without accessories and with clean filters.

NOMINAL CONDITIONS				
SUMMER				
Indoor	DRY BULB TEMPERATURE [°C]	27	R.H. [%]	50
Outdoor	DRY BULB TEMPERATURE [°C]	35	R.H. [%]	50
WINTER				
Indoor	DRY BULB TEMPERATURE [°C]	20	R.H. [%]	50
Outdoor	DRY BULB TEMPERATURE [°C]	7	R.H. [%]	85

### 1.3.5.2 Technical characteristics of machines with R32 refrigerant

		C-OU							
MODEL		WIZARDX 3000	WIZARDX 5000	WIZARDX 7500	WIZARDX 10000	WIZARDX 12500	WIZARDX 15000	WIZARDX 20000	
Air flow	[m <sup>3</sup> /h]	3000	5000	7500	10000	12500	15000	20000	
Air flow range	[m <sup>3</sup> /h]	2000 - 3000	3000-5000	5000-7500	7500-10000	10000-12500	12500-15000	15000 - 20000	
Max useful head (standard configuration)	[Pa]	300							
Max useful head (high pressure configuration)	[Pa]	500							
Cooling	Output of RH coil	[kW]	10	20	25	40	45	50	75
	Output of Heat recovery unit	[kW]	17,9	29,5	43,1	58,2	71,9	86,0	119,1
	Total output	[kW]	27,9	49,5	68,1	98,2	116,9	136	194,1
Heating	Output of RH coil	[kW]	11,2	22,4	27	44,8	49,4	54	81
	Output of Heat recovery unit	[kW]	14,1	22,6	33,5	44,9	55,8	66,8	93,6
	Total output	[kW]	25,3	45	60,5	89,7	105,2	120,8	174,6
Cooling	Sensitive heat recovery performance	[%]	77	74,4	73,3	73,8	73,3	73,1	76,8
	Total heat recovery performance	[%]	70,9	70,3	68,3	68,8	68,3	68,3	69,7
Heating	Sensitive heat recovery performance	[%]	77	74,4	73,3	73,8	73,3	73,1	76,8
	Total heat recovery performance	[%]	75,4	74	72	72,6	72	72	75,6
Power consumption (NOMINAL/MAX)	Delivery fan(s) (300Pa)	[kW]	1.23 / 2.4	1.81 / 2.5	2.72 / 3.4	3.59 / 4.6	4.46 / 4.6	5.48 / 6.8	7.64 / 9.2
	Return fan(s) (300Pa)	[kW]	0.92 / 2.4	1.41 / 2.5	2.1 / 2.4	2.78 / 3.5	3.48 / 4.6	4.26 / 4.8	6.02 / 7.0
	Rotary heat recuperator	[kW]	0,04	0,09	0,18	0,37	0,37	0,37	0,37
	Transformers	[kW]	0,7	0,7	0,7	0,7	1	1	1
	Total of WIZARDX	[kW]	2.89 / 5.54	4.01 / 5.79	5.7 / 6.68	7.44 / 9.17	9.31 / 10.57	11.11 / 12.97	15.03 / 17.57
Filtering section		F7 bag filters							
Humidification section (accessory)	[kg/h]	8	15	18	25	35	45	65	

All the data are for nominal conditions, unit without accessories and filters with medium fouling.

E-OU										
MODEL		WIZARDX 3000	WIZARDX 5000	WIZARDX 7500	WIZARDX 10000	WIZARDX 12500	WIZARDX 15000	WIZARDX 20000		
Air flow	[m <sup>3</sup> /h]	3000	5000	7500	10000	12500	15000	20000		
Air flow range	[m <sup>3</sup> /h]	2000 - 3000	3000-5000	5000-7500	7500-10000	10000-12500	12500-15000	15000 - 20000		
Max useful head (standard configuration)	[Pa]	300								
Max useful head (high pressure configuration)	[Pa]	500								
Cooling	Output of RH coil	[kW]	10	20	25	40	42	50	75	
	Output of Heat recovery unit	[kW]	17,9	29,5	43,1	58,2	71,9	86,0	119,1	
	Total output	[kW]	27,9	49,5	68,1	98,2	113,9	136	194,1	
Heating	Output of RH coil	[kW]	12	22,4	28	44,8	48	54	81	
	Output of Heat recovery unit	[kW]	14,1	22,6	33,5	44,9	55,8	66,8	93,6	
	Total output	[kW]	26,1	45	61,5	89,7	103,8	120,8	174,6	
Cooling	Sensitive heat recovery performance	[%]	77,0	74,4	73,3	73,8	73,3	73,1	76,8	
	Total heat recovery performance	[%]	70,9	70,3	68,3	68,8	68,3	68,3	69,7	
	Heating	Sensitive heat recovery performance	[%]	77,0	74,4	73,3	73,8	73,3	73,1	76,8
Heating	Total heat recovery performance	[%]	75,4	74,0	72,0	72,6	72,0	72,0	75,6	
	Power consumption (NOMINAL/MAX)	Delivery fan(s) (300Pa)	[kW]	1.23 / 2.4	1.81 / 2.5	2.72 / 3.4	3.59 / 4.6	4.46 / 4.6	5.48 / 6.8	7.64 / 9.2
		Return fan(s) (300Pa)	[kW]	0.92 / 2.4	1.41 / 2.5	2.1 / 2.4	2.78 / 3.5	3.48 / 4.6	4.26 / 4.8	6.02 / 7.0
Rotary heat recuperator		[kW]	0,04	0,09	0,18	0,37	0,37	0,37	0,37	
Transformers		[kW]	0,7	0,7	0,7	0,7	1	1	1	
Total of WIZARDX		[kW]	2.89 / 5.54	4.01 / 5.79	5.7 / 6.68	7.44 / 9.17	9.31 / 10.57	11.11 / 12.97	15.03 / 17.57	
Filtering section		F7 bag filters								
Humidification section (accessory)	[kg/h]	8	15	18	25	35	45	65		

All the data are for nominal conditions, unit without accessories and filters with medium fouling.

B-OU										
MODEL		WIZARDX 3000	WIZARDX 5000	WIZARDX 7500	WIZARDX 10000	WIZARDX 12500	WIZARDX 15000	WIZARDX 20000		
Air flow	[m <sup>3</sup> /h]	3000	5000	7500	10000	12500	15000	20000		
Air flow range	[m <sup>3</sup> /h]	2000 - 3000	3000-5000	5000-7500	7500-10000	10000-12500	12500-15000	15000 - 20000		
Max useful head (standard configuration)	[Pa]	300								
Max useful head (high pressure configuration)	[Pa]	500								
Cooling	Output of RH coil	[kW]	20	34	50	60	80	100	125	
	Output of Heat recovery unit	[kW]	17,9	29,5	43,1	58,2	71,9	86,0	119,1	
	Total output	[kW]	37,9	63,5	93,1	118,2	151,9	186	244,1	
Heating	Output of RH coil	[kW]	22,4	38,4	54	67,2	89,6	108	135	
	Output of Heat recovery unit	[kW]	14,1	22,6	33,5	44,9	55,8	66,8	93,6	
	Total output	[kW]	36,5	61	87,5	112,1	145,4	174,8	228,6	
Cooling	Sensitive heat recovery performance	[%]	77	74,4	73,3	73,8	73,3	73,1	76,8	
	Total heat recovery performance	[%]	70,9	70,3	68,3	68,8	68,3	68,3	69,7	
	Heating	Sensitive heat recovery performance	[%]	77	74,4	73,3	73,8	73,3	73,1	76,8
Heating	Total heat recovery performance	[%]	75,4	74	72	72,6	72	72	75,6	
	Power consumption (NOMINAL/MAX)	Delivery fan(s) (300Pa)	[kW]	1.23 / 2.4	1.81 / 2.5	2.72 / 3.4	3.59 / 4.6	4.46 / 4.6	5.48 / 6.8	7.64 / 9.2
		Return fan(s) (300Pa)	[kW]	0.92 / 2.4	1.41 / 2.5	2.1 / 2.4	2.78 / 3.5	3.48 / 4.6	4.26 / 4.8	6.02 / 7.0
Rotary heat recuperator		[kW]	0,04	0,09	0,18	0,37	0,37	0,37	0,37	
Transformers		[kW]	0,7	0,7	0,7	0,7	1	1	1	
Total of WIZARDX		[kW]	2.89 / 5.54	4.01 / 5.79	5.7 / 6.68	7.44 / 9.17	9.31 / 10.57	11.11 / 12.97	15.03 / 17.57	
Filtering section		F7 bag filters								
Humidification section (accessory)	[kg/h]	8	15	18	25	35	45	65		

All the data are for nominal conditions, unit without accessories and filters with medium fouling.

### 1.3.6 Packaging of standard units

In their standard packaging, units are supplied with air inlet and air outlet protections. They are also supplied with lifting and handling brackets.

Three possible packaging solutions are available on request:

- Shrink wrapping: the standard packaging is further protected with shrink wrapping and reinforced corners.
- Container packaging: the machine is protected with shrink wrapping and reinforced corners, and is supplied with slides and bar for shipping in containers.

All the indications concerning the handling of the machine can be found in the dimensional drawing. The dimensional drawing is stored inside the electrical panel of the unit, together with all the accompanying documentation.

### 1.3.7 Information on the packaging

On the outside of shrink-wrapped units are dispatch labels and the drawing showing how to lift and handle the unit. All the other information regarding the unit can be found and are only visible after removing the shrink wrapping.

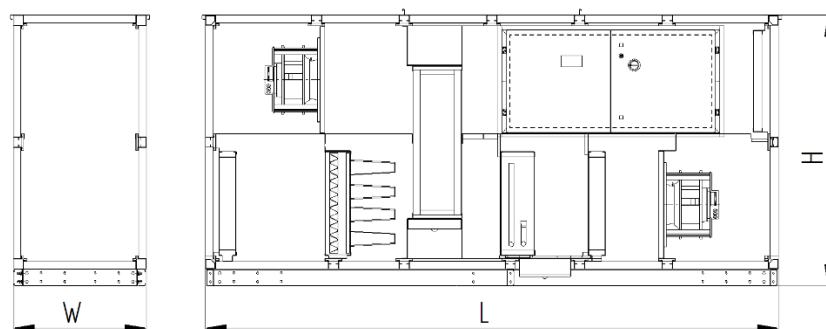

#### Dimensions and weight data of standard units

C-OU and E-OU versions	Q	W	H	L	N.	WEIGHT
	[m <sup>3</sup> /h]	[mm]	[mm]	[mm]	SECTIONS	[kg]
<b>WIZARDX 3000</b>	3000	1000	1600	3400	1	850
<b>WIZARDX 5000</b>	5000	1400	1600	3400	1	1000
<b>WIZARDX 7500</b>	7500	1500	2200	3400	1	1150
<b>WIZARDX 10000</b>	10000	1800	2200	3400	1	1350
<b>WIZARDX 12500</b>	12500	2000	2300	3400	1	1600
<b>WIZARDX 15000</b>	15000	2200	2360	3800	3	1950
<b>WIZARDX 20000</b>	20000	2500	2820	3800	6	2300

B-OU version	Q	W	H	L	N.	WEIGHT
	[m <sup>3</sup> /h]	[mm]	[mm]	[mm]	SECTIONS	[kg]
<b>WIZARDX 3000</b>	3000	1000	1600	3400	1	860
<b>WIZARDX 5000</b>	5000	1400	1600	3400	1	1020
<b>WIZARDX 7500</b>	7500	1500	2200	3400	1	1180
<b>WIZARDX 10000</b>	10000	1800	2200	3400	1	1380
<b>WIZARDX 12500</b>	12500	2000	2300	3400	1	1640
<b>WIZARDX 15000</b>	15000	2200	2360	3800	3	1990
<b>WIZARDX 20000</b>	20000	2500	2820	3800	6	2360

The electrical and mechanical connection of single-section WIZARDX units is done directly at the factory.

Refer to the chapter "JOINING THE SECTIONS" for the electrical and mechanical connection of WIZARDX units in more than one section.

#### Dimensions and weight data of the units divided into five sections (solution on request)

C-OU and E-OU versions	Q	W	H	L	N.	WEIGHT
	[m <sup>3</sup> /h]	[mm]	[mm]	[mm]	SECTIONS	[kg]
<b>WIZARDX 3000</b>	3000	1000	1660	3520	5	890
<b>WIZARDX 5000</b>	5000	1400	1660	3520	5	1050
<b>WIZARDX 7500</b>	7500	1500	2260	3520	5	1210
<b>WIZARDX 10000</b>	10000	1800	2260	3520	5	1420
<b>WIZARDX 12500</b>	12500	2000	2360	3520	5	1680
<b>WIZARDX 15000</b>	15000	2200	2420	3800	5	2050
<b>WIZARDX 20000</b>	20000	2500	2820	3800	6	2300

B-OU version	Q	W	H	L	N. SECTIONS	WEIGHT
	[m <sup>3</sup> /h]	[mm]	[mm]	[mm]		[kg]
<b>WIZARDX 3000</b>	3000	1000	1660	3520	5	900
<b>WIZARDX 5000</b>	5000	1400	1660	3520	5	1070
<b>WIZARDX 7500</b>	7500	1500	2260	3520	5	1240
<b>WIZARDX 10000</b>	10000	1800	2260	3520	5	1450
<b>WIZARDX 12500</b>	12500	2000	2360	3520	5	1720
<b>WIZARDX 15000</b>	15000	2200	2420	3800	5	2090
<b>WIZARDX 20000</b>	20000	2500	2820	3800	6	2360

**CAUTION:**

The packaging used to protect the machine must always be kept out of the reach of children as it represents a hazard.

## 2 TRANSPORT, STORAGE AND INSTALLATION

### 2.1 Transport and handling instructions

**CAUTION:**

The weights indicated in the unit dimensional drawings are with the exchangers empty, without water load.

#### 2.1.1 Storage

If the units are not installed immediately upon receipt, they must be kept in a dry and clean place ready for future use. The openings must be protected to prevent dirtying of and/or damage to the internal and external parts of the unit, as well as the intrusion of water and foreign bodies. The electrical panels must remain closed.

During storage and transport, keep the machine within the following temperature ranges (wider ranges are possible but must be discussed when ordering):

Coolant	R410A - R32
T min (°C)	<b>-10</b>
T max (°C)	<b>46</b>

**INFORMATION:**

For the storage of units containing R32, depending on the quantity, it may be necessary to check the fire prevention certificate to validate the company warranty.

- Even with the unit off, prevent the fluids in contact with the heat exchangers from exceeding the limits indicated in this manual, or from freezing.
- When there is a hydraulic circuit, do not use fluids other than water or mixtures of water and ethylene/propylene glycol at the maximum concentration allowed for the components installed.
- The unit may only be used for the purpose it was designed for. Any other use may be dangerous and will void the warranty.



- Carrying out maintenance on the product can be dangerous: in the event of a fault or malfunctioning, please contact an authorised assistance centre.
- The installation must ensure that the temperature of the fluid entering the unit is kept stable and within the prescribed limits. Attention must be paid when adjusting any external heat exchanging and control equipment (dry coolers, cooling towers, zone valves, etc.), when sizing the mass of fluid circulating through the system (particularly when parts of the system are excluded) and when installing systems for circulating the required amount of fluid, in order to keep the temperature of the machine within the permitted ranges (e.g. during start-up).
- In units with compressors in parallel, do not disable the individual compressors for long periods of time. Always prefer the "demand limit" function.
- If necessary, use the emergency circuit breaker to disconnect the unit from the power supply.

### 2.1.2 Transport

For road transport, it is advisable to use a low loader truck with tarpaulin, or in any case to use tarpaulin to protect the machines against bad weather. Prevent water from entering the air inlet and outlet ports. Use straps with a ratchet system to secure the unit for the purpose of transport.



#### **INFORMATION:**

To avoid damaging the unit, it is advisable to protect the contact points between the strap and the machine with resilient material of adequate thickness. Avoid securing the straps too tightly on the load. For more information, contact the Shipping Office of the manufacturer.

### 2.1.3 Unloading and handling

During lifting and handling, always make sure that the location and the path being followed are such to ensure fully safe activities. In particular, before and during the activities, the customer must ensure that the right and adequate conditions are in place for safe transport:

- sufficient visibility and lighting;
- the lifting equipment support and travel surfaces must have adequate bearing capacity taking into account the total loads, must not be slippery or excessively sloping;
- there must be no potholes or obstacles;
- there must be no water or moisture.

Particular attention should be paid to weather conditions especially during operations outdoors. Transport and lifting operations must not be carried out under conditions of snow, ice, rain or thunderstorms or when there are strong winds.

During all the transport stages, care should be taken not to cause imbalance of the load, which can be due to, for example, inadequate grip, oscillation, movement of parts of the unit that shift the centre of gravity, or excessive accelerations or decelerations.

The customer must prevent all unauthorised access to the area where transport, handling and lifting operations are carried out in and outside the area where the unit will be installed.

The manual handling of the loads can cause musculoskeletal disorders.

When handling the loads manually, make sure that the weight of the parts to be lifted is not too heavy for the operator to lift, in accordance with the domestic laws and regulations in force.

In any case, the weight of the objects to be lifted manually must not exceed 25 kg for each operation performed by a single operator and not more than 40 kg for each lifting operation performed by 2 operators. These values are based on the assumption of trained male operators familiar with the manual handling of loads and who are in good physical shape; carrying of the load against the body using the grips that guarantee a secure hold and stability of the load; a working environment without any obstructions; and optimal thermo-hygrometric conditions.

The customer should consider any aggravating circumstances and reduce the recommended maximum weight accordingly.

The unit or its parts should only be lifted and transported using suitable lifting equipment (forklift trucks or pallet trucks when indicated on the pack, or lifting cranes when lifting brackets are fitted) compliant with the domestic legislation and regulations in force. The lifting gear and any accessories used must have a sufficient load capacity for lifting the unit or individual parts to be moved.

The lifting gear and accessories must be in good condition and must be prepared, installed, maintained, monitored, checked, tested, operated and used in accordance with the manufacturer's instructions, the rules of good practice and the domestic laws and regulations that apply.

The lifting equipment and/or ropes and/or other lifting accessories to be fitted between the lifting device and the load (chains, slings, hooks, sling bars) are not provided by the manufacturer.

Operators lifting and/or transporting the unit or the individual packages (the customer, the freight forwarder and/or the installer) must only choose and use lifting accessories that comply with European regulations, and/or national regulations of the country of use. The accessories must be in good condition and subjected to regular controls, checks, and maintenance, in accordance with the manufacturer's instructions, as well as European regulations and national laws of the country of use.

It is mandatory to use suitable lifting equipment that can withstand the total weight of the load to be lifted and is compliant with the domestic laws and regulations that apply.

It is mandatory to ensure the suitability of the lifting accessories which must be chosen on the basis of the loads to be lifted and the lifting procedures, avoiding excessive tension of the ropes, slings and chains and avoiding use of the accessories outside the limit load for which they were designed and built.

Make sure, in particular, that the ropes, slings and chains remain at an angle at which the load on each rope, sling or chain can be kept below its limit load.

The use of inappropriate lifting equipment may result in injury to the personnel involved in the operation and/or damage to the unit.

In case of lifting with helicopter, pay particular attention to the "sealing" of the openings on the machine. It is essential that there are no areas where air can enter the unit.

During the flight, the flow of air into the machine at high speed could cause the various panels to break with repercussions also in terms of safety.

Failure to observe the above and any harm caused to persons, animals or property relieves the manufacturer of all liability.

Before handling the machine, carefully read the following instructions.



**CAUTION:**

All the unloading, handling and positioning operations must be carried out using appropriate means and by experience personnel, trained and authorised for such activities.

#### 2.1.4 Receipt and inspection of the equipment

Upon receipt, verify the integrity of the machine and check it against the order.

- Check the number of packages against the transport document. If incorrect, notify the carrier and the distributor.
- Perform a visual inspection of the packaging, when applicable.
- Check that the outside of the machine has not been damaged in any way.
- Check that the equipment supplied corresponds to the order and the delivery note.

In the event of damage to the product, please provide details in writing and with reserve and send the report to the shipper by registered mail within 48 hours of delivery (working days). Please also send a copy of the letter to the retailer and the supplier or distributor. Failure to comply with this procedure will render any claims to the shipper null and void.

If the machine is not installed upon receipt but is put into storage for a long period, set it aside in a protected environment following the instructions in the chapter 2 "STORAGE".



**OBLIGATION:**

If any of the packages are damaged or missing, contact the Sales Office of the manufacturer and the freight forwarder, to agree the next plan of actions.

## Technical data plate

The technical data plate (see the example in the chapter 1.2 "Nomenclature") provides the main information needed for electrical connection of the unit and for proper maintenance. The supply voltage must not exceed +10/-10 %. The power absorbed at full capacity FLI represents the maximum value that can be reached for the specified operating voltage. The power supply line must be sized according to the current absorbed by the unit at full capacity, or FLA. The customer must have an adequate power supply system. It is therefore important to check that the power supply voltage indicated on the rating plate of the unit is compatible with that of the customer's electrical system.

The data plate also indicates the year of manufacture, model and serial number, the maximum permissible pressures in the hydraulic circuit, the code of the wiring diagram and the operating weight of the unit.



### INFORMATION:



The data on the name plates of WIZARDX units only refer to such units. For information regarding Mr. Slim condensing units, refer to the relative documentation.

## Identification of the sections

The unit may have been delivered in several sections.

The various sections making up the unit each have a serial number label (see example below) bearing the serial number of the main unit.

All parts with the same serial number must be assembled to form a single unit.

Cod. 084985	Mod.157 rev.01
<b>Costruttore / Manufacturer</b> <b>Mitsubishi Electric Hydronics &amp; IT Cooling Systems</b>	
<b>Modello / Model</b>	
<b>Matricola unità / Serial number</b> 	
<b>Conferma d'ordine n° / Acknowledgment n°</b> 	
<b>n° ordine cliente / Customer order n°</b>	
<b>Indirizzo di spedizione / Shipping address</b>	
<b>Marchatura / Goods marking</b>	
<b>Sezioni / Sections</b>	

## Demountable unit (optional)

For transport or handling in cramped environments and with narrow passages, the units can be supplied as "demountable". In this case, the individual sections can be disassembled to minimize the size or weight of the individual parts.

Depending on its size, the machine will be shipped assembled or divided into its standard sections.

During reassembly, the installer must take all the necessary measures to ensure that the machine can work properly (no air leakage, no water seepage, etc.)

**Modular unit (optional)**

The unit will be shipped split into sections as shown in the table below. Once the components have been transferred to the installation site, the machine can be re-assembled.

In this case, the materials required for final assembly (strap, brackets, screws, etc.) will be supplied in the "delivery fan" section. The technical documentation of the unit will be provided in the same section.

C-OU and E-OU versions	<b>Q</b>	<b>W</b>	<b>H</b>	<b>L</b>	<b>N. SECTIONS</b>	<b>WEIGHT</b>
	<b>[m<sup>3</sup>/h]</b>	<b>[mm]</b>	<b>[mm]</b>	<b>[mm]</b>		<b>[kg]</b>
<b>WIZARDX 3000</b>	3000	1000	1660	3520	5	890
<b>WIZARDX 5000</b>	5000	1400	1660	3520	5	1050
<b>WIZARDX 7500</b>	7500	1500	2260	3520	5	1210
<b>WIZARDX 10000</b>	10000	1800	2260	3520	5	1420
<b>WIZARDX 12500</b>	12500	2000	2360	3520	5	1680
<b>WIZARDX 15000</b>	15000	2200	2420	3800	5	2050
<b>WIZARDX 20000</b>	20000	2500	2820	3800	6	2300

B-OU version	<b>Q</b>	<b>W</b>	<b>H</b>	<b>L</b>	<b>N. SECTIONS</b>	<b>WEIGHT</b>
	<b>[m<sup>3</sup>/h]</b>	<b>[mm]</b>	<b>[mm]</b>	<b>[mm]</b>		<b>[kg]</b>
<b>WIZARDX 3000</b>	3000	1000	1660	3520	5	900
<b>WIZARDX 5000</b>	5000	1400	1660	3520	5	1070
<b>WIZARDX 7500</b>	7500	1500	2260	3520	5	1240
<b>WIZARDX 10000</b>	10000	1800	2260	3520	5	1450
<b>WIZARDX 12500</b>	12500	2000	2360	3520	5	1720
<b>WIZARDX 15000</b>	15000	2200	2420	3800	5	2090
<b>WIZARDX 20000</b>	20000	2500	2820	3800	6	2360

## 2.1.5 Handling



### PROHIBITION:

It is strictly forbidden to move or lift the unit after joining its sections.



### OBLIGATION:

It is mandatory to move or lift the sections.

Before handling the unit, carefully read the instructions below and the indications of the yellow label on the product and in the lifting drawing, as well as the instruction manual of the lifting equipment used.



The lifting drawing is part of the accompanying documentation and this documentation is on the product.

Handling and transport must be carried out by qualified personnel using suitable personal protective equipment and materials suited to the weight and size of the unit.

The units have lifting brackets with closed ring.

Use all, and only, the lifting points indicated in the dimensional drawing and marked on the unit.

To lift and move the units, use the brackets shown below which may be fitted on the unit and are identified by a special label:



When the lifting brackets are installed on the coupling side of the module, then for coupling together the modules only use the brackets shown below, denoted by the label that identifies the coupling brackets.

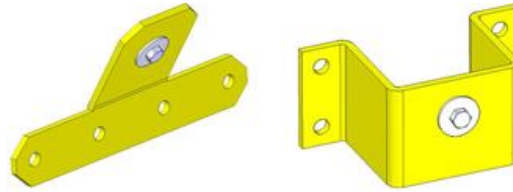

Sample images showing what discussed above. The unit layout may vary depending on size. Refer to the corresponding dimensional drawing.

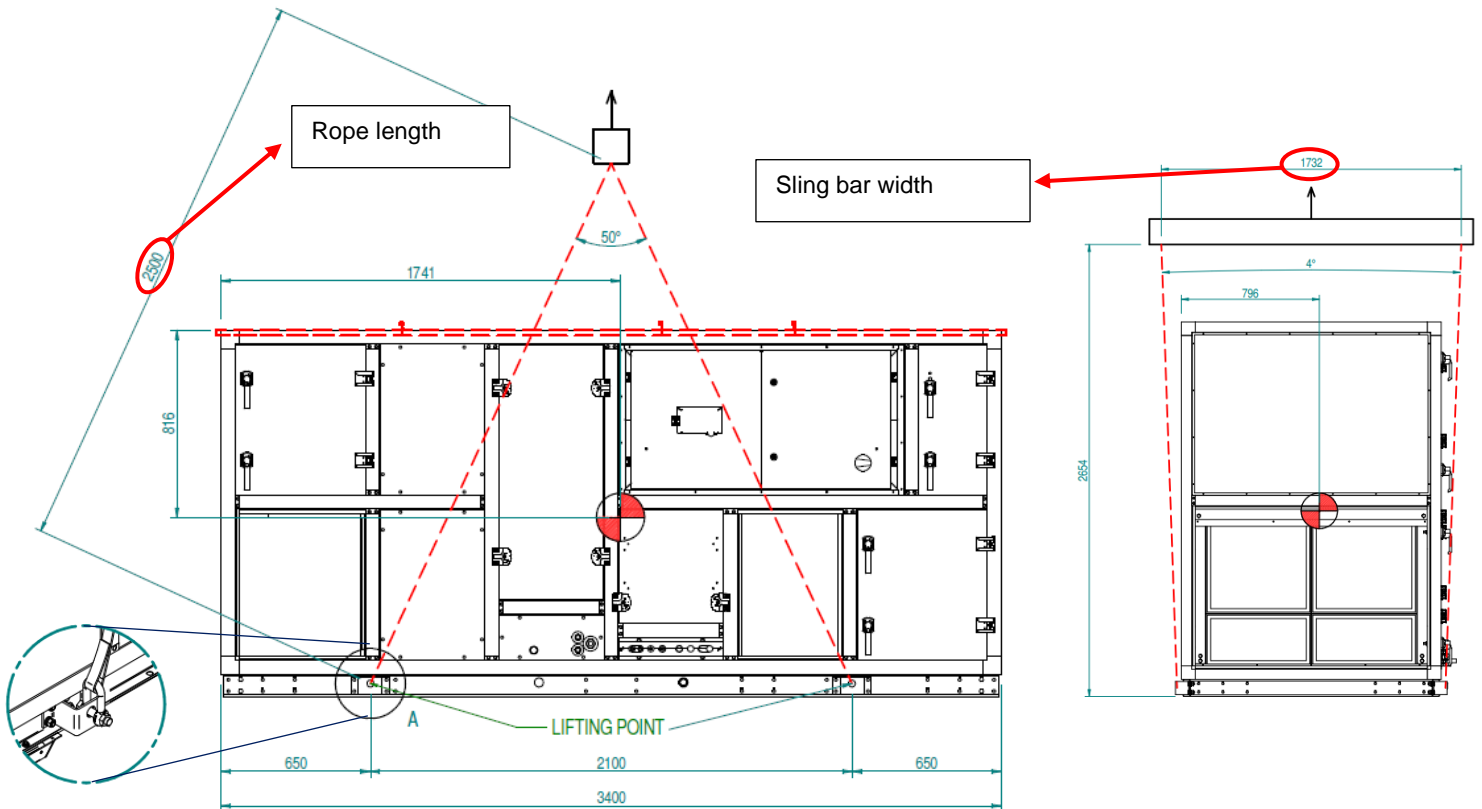

Implement the following measures:

1. handle the unit at an ambient temperature above  $-10^{\circ}\text{C}$  and when there is no wind;
2. make sure that no unit components are damaged and that they are correctly installed;
3. use all, and only, the lifting points indicated in the dimensional drawing and marked on the unit;
4. use cables of suitable load-bearing capacity and length, as indicated in the dimensional drawing;
5. make sure that the ropes are securely attached to the unit using suitable devices;
6. it is obligatory to use a sling bar of suitable weight-bearing capacity to guarantee stability when lifting and to prevent the cables from coming in contact with the unit;

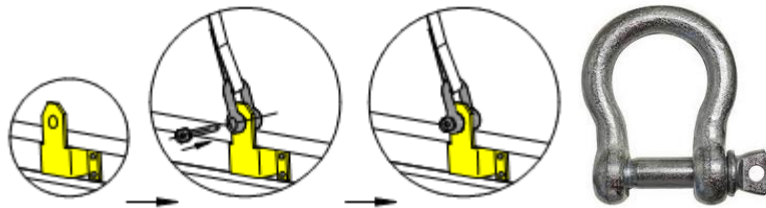

7. make sure that the lifting ropes will not damage the machine during lifting.  
If it is not possible to keep the ropes away from the unit, place appropriate protection materials between the two;
8. move the machine carefully and avoid abrupt movements;
9. keep at a safe distance and do not, for any reason, stand with parts of the body under or near the lifted unit;

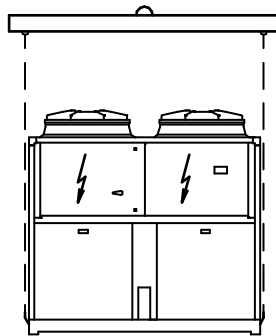

10. move the unit carefully and avoid abrupt movements. Do not tilt the machine more than  $6^{\circ}$  during handling;
11. keep at a safe distance and do not, for any reason, stand with parts of the body under or near the lifted unit.

The surface on which the unit is placed must be level and sufficiently strong to take the weight of the machine when full of water and running, as indicated in the dimensional drawing.

To reduce vibrations to the supporting structures, assemble vibration dampers at each fastening point indicated in the dimensional drawing.

Install the vibration dampers under the base with the unit lifted no more than 200 mm off the ground and avoid standing with parts of the body under the unit.

In any case, always secure the unit on the support base. The vibration dampers may extend outside the span of the machine and, in which case, will require suitable support.

In the case of installation on a raised surface, make sure that the handle of the power disconnecter is easy to access and at a height of between 0.6m and 1.9m above the floor (EN60204-1).

## 2.2 Installation instructions

### 2.2.1 Installation of the standard machine



**OBLIGATION:**

Always read the specific manual.



**CAUTION:**

All the installation stages must be included in the general system design.

Before installing the equipment, it is **mandatory** to carry out the following checks:

- There must be sufficient space in which to install the unit observing the minimum required clearances indicated in this manual.
- The area must be perfectly flat and guarantee stability over time.
- The surface on which the equipment is to be installed must be strong enough to withstand its weight. A preliminary assessment of the overall situation is necessary.
- The openings of the delivery and recirculation ducts should not weaken the structure.
- There must not be any obstructions that could prevent the equipment from working properly.
- The air suction and delivery must not be obstructed in any way, even partially.
- The power of the electric system must be compatible with the electrical specifications of the equipment.
- A condensate drain must be put in place.
- The area must be easy to access for all those who have to interact with it during its life span.
- There must be sufficient space for maintenance.
- Check that it is possible to perform all maintenance and replacement operations (routine and extraordinary) easily and without risks to people, and in compliance with the laws in force concerning safety at work.
- Make sure that the unit is installed in accordance with the applicable domestic rules and regulations in force.
- Do not install on uneven surfaces.
- Do not install two units near or adjacent to each other, because excessive proximity can reduce the intake of air (see para. "Clearances for installation").
- The machine must be installed in a non-aggressive atmosphere.
- Before installing a unit, it is important to consider:
  - o the direction and location of the air flows;
  - o the external dimensions of the unit and the size of the air duct connections;
  - o the arrangement of the inspection doors and any hydraulic connections;
  - o the space required to open the inspection doors and to access the various components.
- In general, make sure that there are no obstacles (walls, trees or roof edges) that could interfere with duct connections or prevent mounting and access for maintenance.
- The place of installation of the unit must be set up to ensure uniform support for the under-frames of the unit, and keep the base of the unit parallel with the ground.
- Check the waterproofing of areas where rainwater is free to flow.
- The unit must be installed according to the requirements of standard EN 378-3 and the local regulations in force, in particular taking into account the category of occupation of the premises and the safety class defined by EN 378-1.

Coolant	R410A	R32
Safety class	A1	A2L



**INFORMATION:**

R32 gas is classified as slightly flammable.

In case of leakage, in order to ensure a refrigerant concentration below the safety limit, the installer/maintenance technician must provide adequate ventilation.

- Air-cooled machines must be protected against wind, which can affect condensation control and prevent defrosting in the heat pumps. The finned coils must also be protected against dirt (dust, leaves, wood chips, etc...) and atmospheric conditions that can cause corrosion.

**CAUTION:**

Maintenance technicians must only work on the unit's controls. They should not open any panels, other than the access panel to the control module.

The installer must limit him/herself to connecting the plant to the unit.

Access the unit using the relative personal protective equipment and only after having read and understood the documents and instructions, which must always be kept close at hand.

**2.2.1.2 Minimum installation area for units with R32**

The selection of the unit must be made by the installer taking into account the minimum square footage requirements shown in the table below.

The unit itself cannot be intended as a safety feature for the indoor environment.

The responsibility for proper installation and safety of the environments served by the unit rests entirely with the installer.

For installations that do not comply with the table, the environment must be adapted in accordance with the chapters on additional safety of the EN378-3 standard and the applicable local regulations.

The installer is fully responsible for the sizing activities and the implementation of these additional safety measures.

The minimum surface sizes to comply with are given for each size, referred to the smallest room served by the unit at the installation site.

The "h<sub>0</sub>" reference height must be considered starting from the height from the floor of the lowest vent in the room.

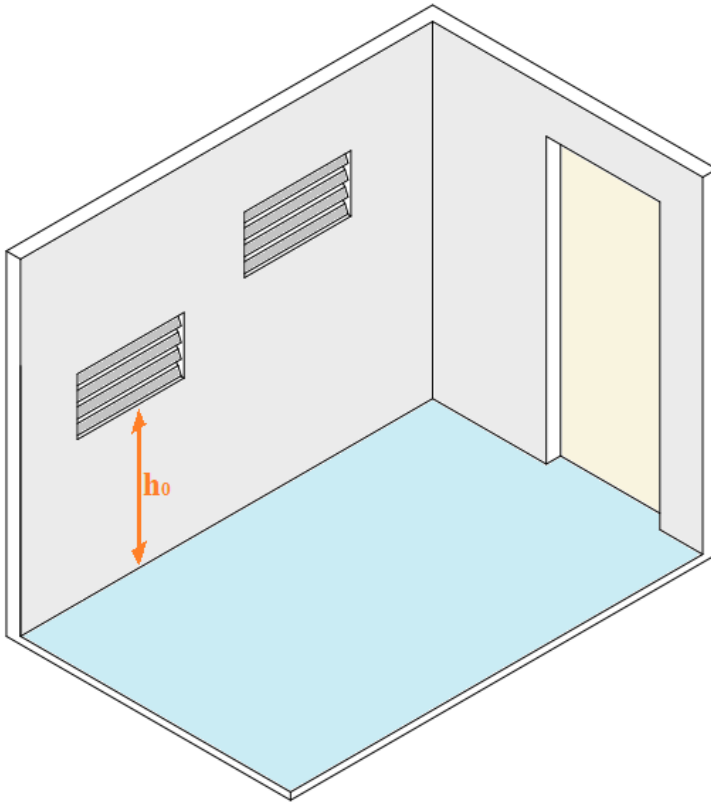

WIZARDX-G07 5000			
h <sub>0</sub> (EN 378-1 ANNEX C.2)	Amin [m <sup>2</sup> ] C-OU	Amin [m <sup>2</sup> ] B-OU	Amin [m <sup>2</sup> ] E-OU
0.6	306	338	338
1	110	122	122
1.8	34	38	38
2.2	23	25	25

WIZARDX-G07 10000			
h <sub>0</sub> (EN 378-1 ANNEX C.2)	Amin [m <sup>2</sup> ] C-OU	Amin [m <sup>2</sup> ] B-OU	Amin [m <sup>2</sup> ] E-OU
0.6	338	338	338
1	122	122	122
1.8	38	38	38
2.2	25	25	25

WIZARDX-G07 15000			
h <sub>0</sub> (EN 378-1 ANNEX C.2)	Amin [m <sup>2</sup> ] C-OU	Amin [m <sup>2</sup> ] B-OU	Amin [m <sup>2</sup> ] E-OU
0.6	394	394	394
1	142	142	142
1.8	44	44	44
2.2	29	29	29

WIZARDX-G07 3000			
h <sub>0</sub> (EN 378-1 ANNEX C.2)	Amin [m <sup>2</sup> ] C-OU	Amin [m <sup>2</sup> ] B-OU	Amin [m <sup>2</sup> ] E-OU
0.6	306	306	306
1	110	110	110
1.8	34	34	34
2.2	23	23	23

WIZARDX-G07 7500			
h <sub>0</sub> (EN 378-1 ANNEX C.2)	Amin [m <sup>2</sup> ] C-OU	Amin [m <sup>2</sup> ] B-OU	Amin [m <sup>2</sup> ] E-OU
0.6	306	394	394
1	110	142	142
1.8	34	44	44
2.2	23	29	29

WIZARDX-G07 12500			
h <sub>0</sub> (EN 378-1 ANNEX C.2)	Amin [m <sup>2</sup> ] C-OU	Amin [m <sup>2</sup> ] B-OU	Amin [m <sup>2</sup> ] E-OU
0.6	306	394	338
1	110	142	122
1.8	34	44	38
2.2	23	29	25

WIZARDX-G07 20000			
h <sub>0</sub> (EN 378-1 ANNEX C.2)	Amin [m <sup>2</sup> ] C-OU	Amin [m <sup>2</sup> ] B-OU	Amin [m <sup>2</sup> ] E-OU
0.6	394	394	394
1	142	142	142
1.8	44	44	44
2.2	29	29	29

The above minimum areas have been calculated according to the EN378-1:2016 standard and taking into account Chapter 5:

- The classification of the Position is: II
- Access Category: a.

All restrictions mentioned apply not only to new installations but also to relocations and lay-out changes.

In case of unclear selection situations, contact the manufacturer.

### **2.2.2 Machine positioning**

Before placing the unit in its final position, remove the shims/slides from the base (if provided).

It is advisable to place an elastic rubber seal between the base of the machine and the floor, covering the entire support surface, to prevent the transmission of noise and vibrations. The thickness and the type of rubber must be identified accordingly in order to achieve the above result.

Units composed of multiple sections and the sections available as accessories (steam humidification section and section with three dampers) must be put together, only after lifting them, in accordance with the drawings and paying close attention to the positions of the inspection doors and connectors (these must all be on the same side). For this purpose, identify each section by checking its number on its serial number label and on the dimensional drawing of the unit. See the example below:

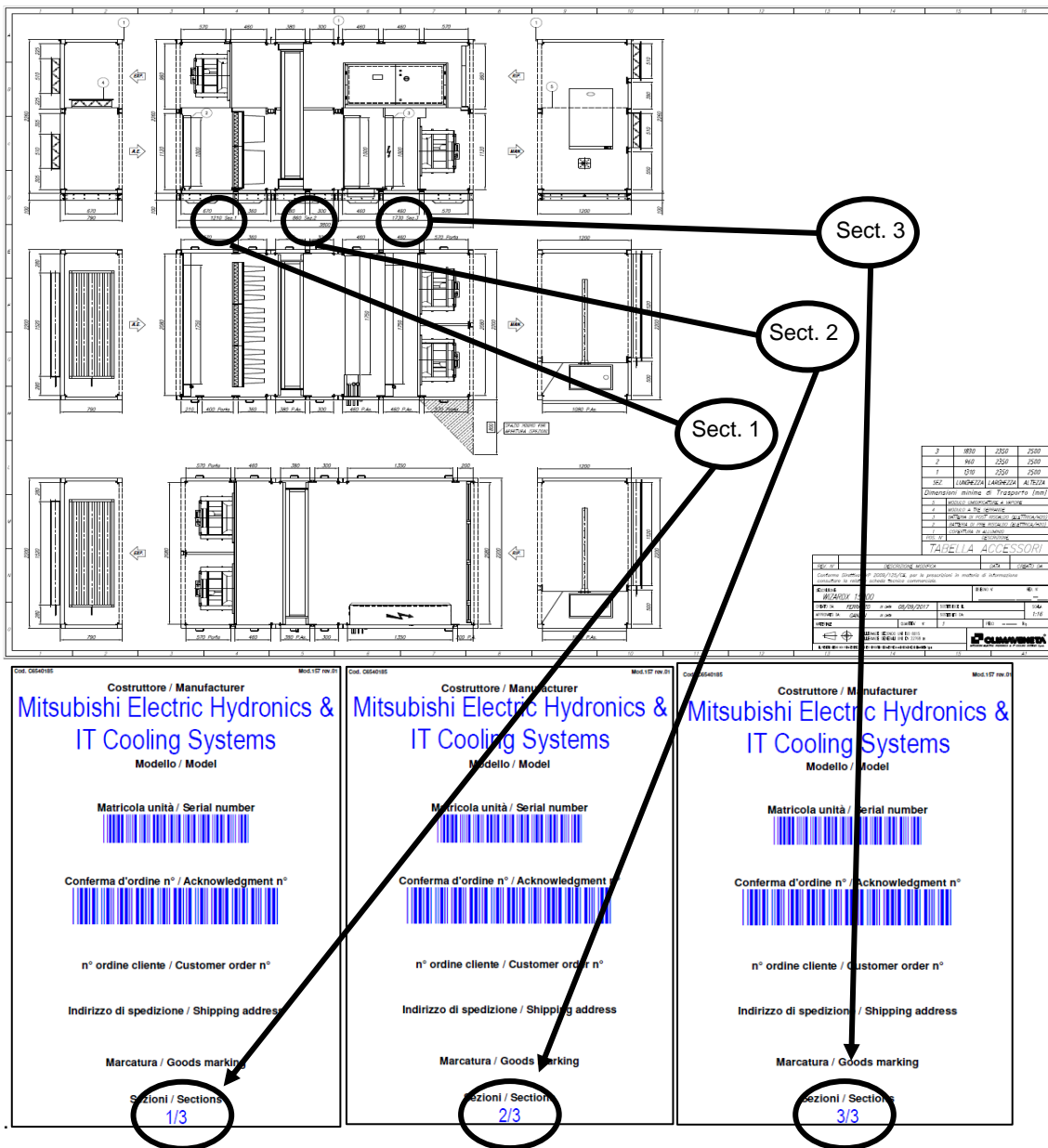

### 2.2.2.2 Joining the sections

The procedure for joining the sections of a unit after lifting is as follows:

1. Check that the order of the sections is exactly the same as shown in the technical drawing supplied.
2. Check that the side with the connectors and inspection doors of the sections is exactly the same as the one shown in the drawing.
3. The material for joining the sections is supplied in a box inside the **delivery fan** section or in the filter access plenums (for small machines).
4. Before joining the sections:
  - clean the section bars and apply the supplied self-adhesive gasket;
  - waterproof the area where the individual modules are coupled together using silicone sealant (fig.A);
  - for units equipped with a weather cover panel, before joining the modules together, apply silicone to the edges of the canopy at the joints, so as to increase the seal of the cover itself (fig.C).
5. Put the sections together, verifying the perfect alignment and planarity of the parts.

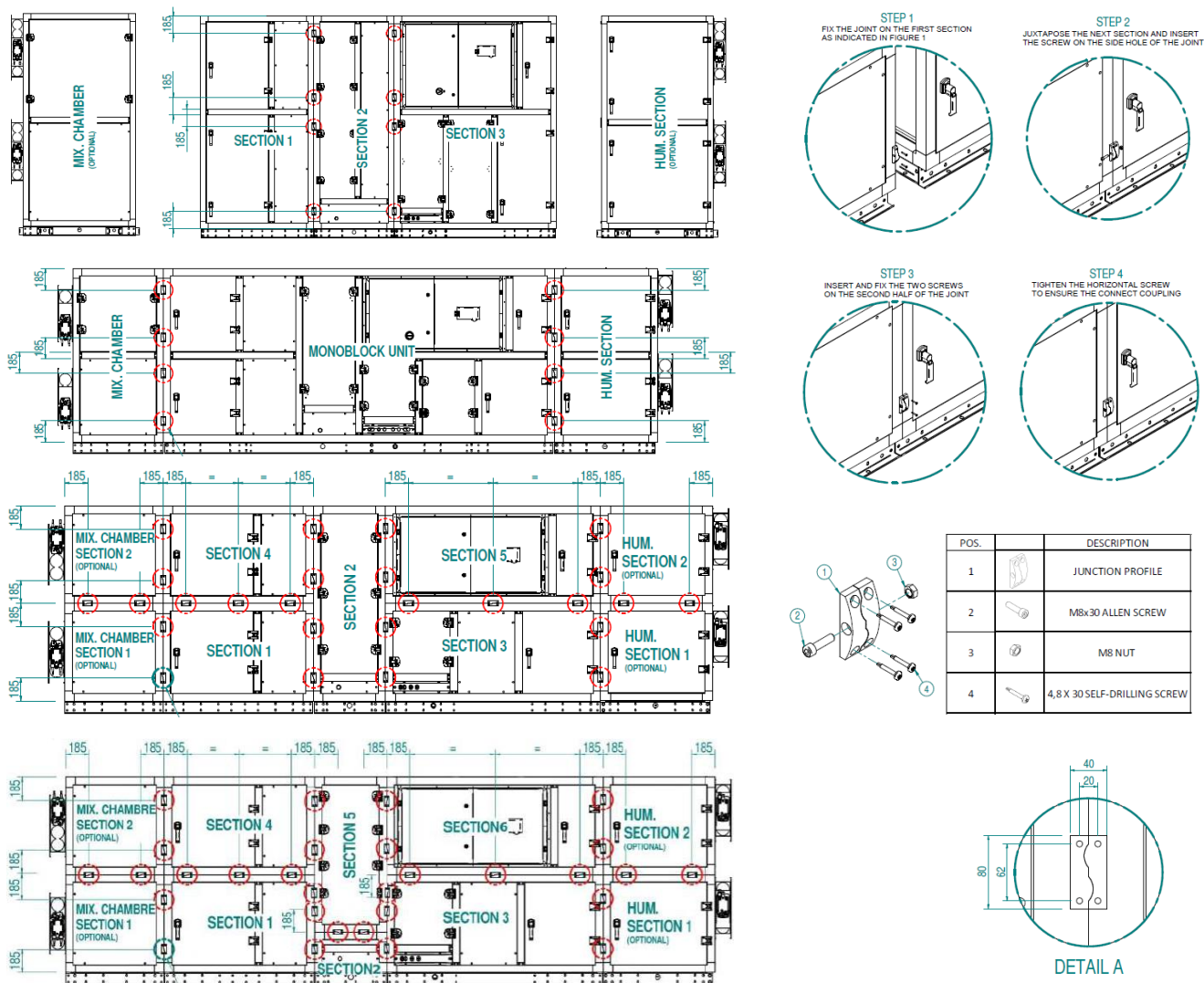

6. Join the sections with the brackets provided, arranging them as shown on the attached drawing in the fan chamber and according to the required configuration of the unit.
7. After assembly, seal the spaces between the individual modules using the silicone provided (fig. B).

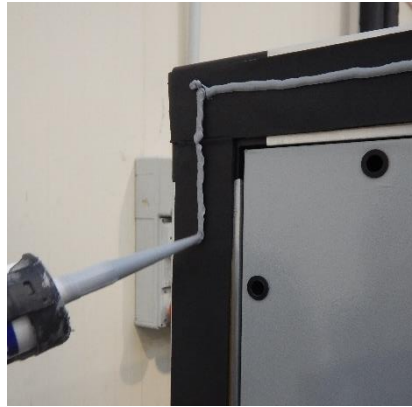

Fig.A



Fig.B

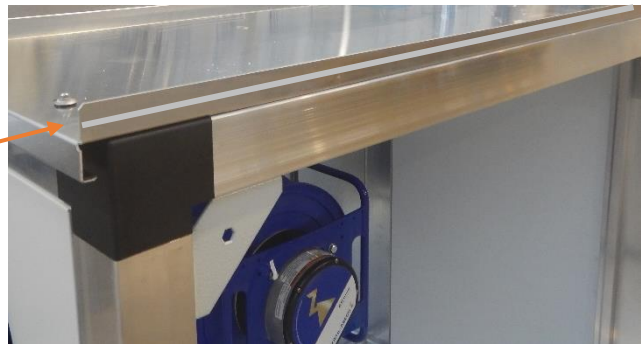
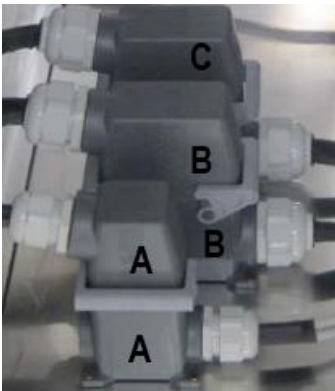

Fig.C

The electrical and mechanical connection of single-section WIZARDX units is done directly at the factory.

After putting the sections together, make the power and signal connection by joining the pairs of connectors with identification labels. (Example: join the female connector labelled with the letter "A" to the male connector labelled with the letter "A"). Below is an example of the possible connectors used:



### 2.2.3 Installation clearances

#### Preliminary checks on the place of installation

Before installing the equipment, it is **mandatory** to carry out the following checks:

- There must be sufficient space in which to install the unit observing the minimum required clearances indicated in this manual.
- The area must be perfectly flat and guarantee stability over time.
- The surface on which the equipment is to be installed must be strong enough to withstand its weight. A preliminary assessment of the overall situation is necessary.
- The openings of the delivery and recirculation ducts should not weaken the structure.
- There must not be any obstructions that could prevent the equipment from working properly.
- The air suction and delivery must not be obstructed in any way, even partially.
- The power of the available electricity supply must be compatible with the electrical specifications of the equipment (WIZARDX units and related Mr. Slim condensing units).
- A condensate drain must be put in place.
- The area must be easy to access for all those who have to interact with it during its life span.
- There must be sufficient space for maintenance.
- Check that it is possible to perform all maintenance and replacement operations (routine and extraordinary) easily and without risks to people, and in compliance with the laws in force concerning safety at work.
- Make sure that the unit is installed in accordance with the applicable domestic rules and regulations in force.
- Do not install on uneven surfaces.
- Do not install two units near or adjacent to each other, because excessive proximity can reduce the intake of air (see para. "Clearances for installation").
- The machine must be installed in a non-aggressive atmosphere.
- Before installing a unit, it is important to consider:
  - o the direction and location of the air flows;
  - o the external dimensions of the unit and the size of the delivery and recirculation connections;
  - o the arrangement of the inspection doors and connectors;
  - o the space required to open the inspection doors and to access the various components.
- In general, make sure that there are no obstacles (walls, trees or roof edges) that could interfere with duct connections or prevent mounting and access for maintenance.
- The place of installation of the unit must be set up to ensure uniform support for the under-frames of the unit, and keep the base of the unit parallel with the ground.
- Check the waterproofing of areas where rainwater is free to flow.
- Suspended installation is possible only when the structure the unit is suspended from has been verified as being able to support the total weight of the air handling unit during operation. Sizing of the support structure and how the unit is anchored to it are the installer's responsibility.

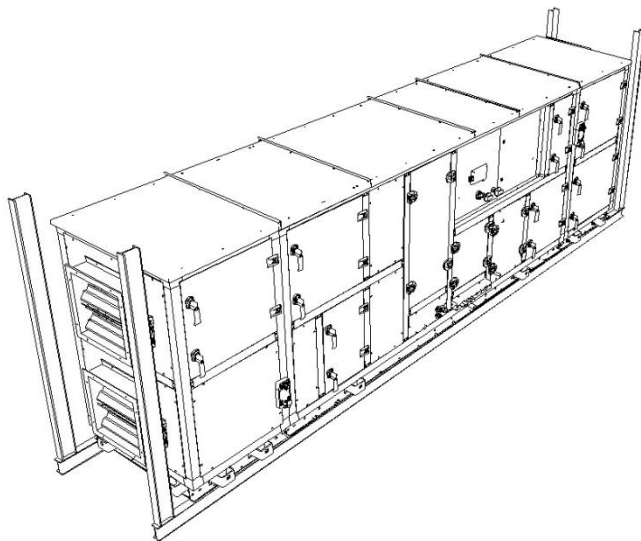

- The unit must be installed according to the requirements of standard EN 378-3 and the local regulations in force, in particular taking into account the category of occupation of the premises and the safety class defined by EN 378-1.

**CAUTION:**

Correct installation of the machine requires compliance with the clearances shown in the figure (plan view of an example of a WIZARDX unit). This allows ease of access to the components of the machine for the purpose of normal inspection and maintenance operations.

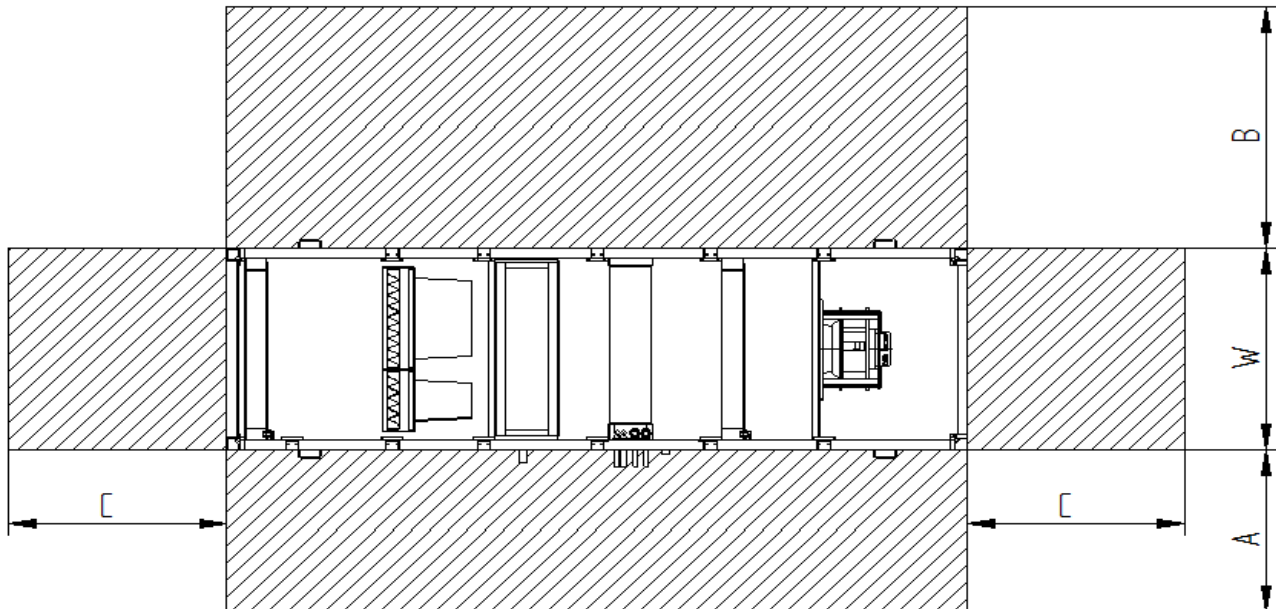

The unit must be put in a position where there is sufficient space for performing routine and extraordinary maintenance. Observe the following points:

- W: width of the WIZARDX unit;
- A: arrange for an area in front of the side of the inspection doors and manifolds that is as long as the machine and of a width of 800 mm;
- B: arrange for an area in front of the side opposite that of the connectors and inspection doors, as long as the machine and of a width equal to the width of the AHU (W) plus 200 mm, so that the coils can be taken out without the need to remove the cooling circuits or valve assemblies. If this area cannot be arranged here (for example if the unit is near a wall), it must instead be arranged in front of the side of the inspection doors and manifolds.
- C: arrange for an area at the point of the air outlet and air inlet of a width equal to the width of the AHU (W) and of a length of 1000 mm.

**INFORMATION:**

In the case of accessories and options (for example a humidifier module or a mixing module), the clearances must be calculated considering the maximum overall dimensions with all the accessories/options provided. Check the dimensions of the accessories/options in the relevant chapter.



The distance between the WIZARDX units and the Mr. Slim condensing units should be such that the length of the connections of the cooling circuits does not exceed 30 m. Connections of the cooling circuits exceeding 30 m can reduce the performance of the unit and cause irreparable damage to, or malfunctioning of the connected machines. The connections of the cooling circuits between the WIZARDX and Mr Slim must be protected against damage.



Maximum length of piping (A) = 30 m



**INFORMATION:**

In the case of accessories and options, the clearances must be calculated considering the maximum overall dimensions with all the accessories/options provided. When two units are set side by side on the battery side, add up the measurements to be respected on the battery side of the two units.

### 2.2.4 Connection of the cooling circuit between WIZARDX and Mr. Slim unit

To ensure correct operation and avoid faults in the connected units, it is necessary to guarantee the correct cooling circuit connection between the circuits of the direct expansion coil (ED) of the WIZARDX unit and the corresponding Mr. Slim condensing unit. Similarly, it is also necessary to guarantee the correct connection of the signals between the PAC-IF interface cards and the corresponding Mr. Slim units.

The DE coil of the WIZARDX units is composed of a number of circuits equal to the number of Mr. Slim condensing units to be combined with the air handling unit; there is a circuit for each Mr. Slim.

The electrical panels of the WIZARDX units include a number of PAC-IF interface cards equal to the number of Mr. Slim condensing units to be combined with the air handling unit; there is a PAC-IF for each Mr. Slim.

The circuit of the DE coil, the Mr. Slim condensing unit and the PAC-IF interface card must be connected to form a closed loop. See the indicative diagram in the section "IDENTIFICATION OF THE CIRCUITS".



**INFORMATION:**

The distance between the WIZARDX units and the Mr. Slim condensing units should be such that the length of the connections of the cooling circuits does not exceed 30 m. Connections of the cooling circuits exceeding 30 m can reduce the performance of the unit and cause irreparable damage to, or malfunctioning of the connected machines.

**CAUTION:**

The cooling circuits must be connected by qualified personnel.

Connection of the cooling circuits, selection of the components, selection of the materials to be used and filling with refrigerant must be carried out with reference to the installation manual provided with the Mr. Slim condensing units combined with the WIZARDX unit.

The cooling circuits must also be connected in compliance with the "code of good practice" and in accordance with the relevant regulations in force in the various countries, taking into account the operating conditions and intended uses of the system.

Errors in the design and/or connection of the cooling circuits can cause irreparable damage to, or malfunctioning of the machine.

Incorrect connections between the cooling circuits of the direct expansion coil of the WIZARDX unit and the Mr. Slim condensing unit can cause irreparable damage to, or malfunctioning of the connected machines

For units with R32 refrigerant charge, the cooling connections must be made entirely outdoor. Under no circumstances, should they pass through enclosed spaces or areas occupied by people.

Cooling circuit connections must only be completed by brazing.

The direct expansion coil in the WIZARDX units is pressurised with nitrogen or dry air in order to protect the exchanger against the intrusion of humidity and permit the identification of any leaks due to handling or storage, at the time of use. Before connecting this coil with the Mr. Slim condensing unit, make sure that it is still pressurized. Otherwise call technical support.

Before connecting this coil to the condensing unit, open the Schrader valves to discharge any nitrogen or dry air inside the coil and cut the copper plugs of the manifolds using a special pipe cutter.

Use appropriate PPE when doing this.



The panel of the WIZARDX unit for the manifold outlet of the direct expansion coil has a protective plate which is to be removed once the cooling circuits have been connected.

Attention: plastic collars are applied to prevent damage to the copper pipes entering and leaving the coil. Before brazing, remove the collars from the panel (both on the inside and on the outside).

After brazing, wait for the pipes to cool down and then put the collars back on again.

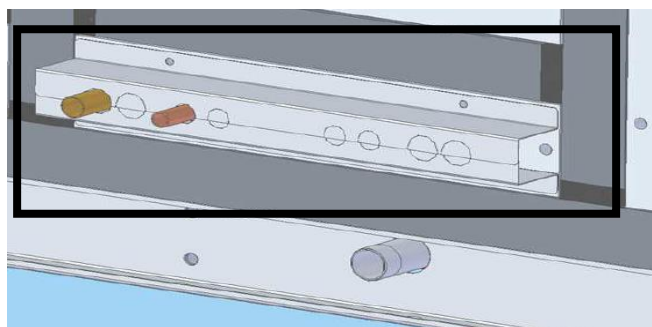

## Identification of the circuits

Before connecting the cooling circuits, it is necessary to identify with precision the circuits of the direct expansion (DE) coil of the WIZARDX unit that are to be connected to the correct Mr. Slim condensing unit.

The manifolds of the DE coil each have a label indicating the number of the circuit to which they belong and the type of line - gas or liquid - to which they must be connected. An example is given below:



When the WIZARDX units are combined with Mr. Slim condensing units of different capacities, the labels on the manifolds of the DE coil also indicate the size of the Mr. Slim to which they must be connected.

### Pipe diameters of manifolds with R410A refrigerant

WIZARDX MODEL		Number of connections x External diameter of connection [mm]						
		3000	5000	7500	10000	12500	15000	20000
C-OU	Gas (G)	1 x 22	1 x 22	1 x 28	2 x 22	1 x 28 + 1 x 22	2 x 28	3 x 28
	Liquid (L)	1 x 16	1 x 22	1 x 22	2 x 22	1 x 22 + 1 x 16	2 x 22	3 x 28
B-OU	Gas (G)	2 x 22	1 X 28 + 1 X 22	2 x 28	3 x 28	4 x 22	4 x 28	5 x 28
	Liquid (L)	2 x 16	1 X 22 + 1 X 16	2 x 28	3 x 22	4 x 22	4 x 22	5 x 28
E-OU	Gas (G)	2 x 16	2 x 22	2 x 22	2 x 22	3 x 22	2 x 28	3 x 28
	Liquid (L)	2 x 12	2 x 16	2 x 16	2 x 22	3 x 16	2 x 22	3 x 28

### Pipe diameters of manifolds with R32 refrigerant

WIZARDX MODEL		Number of connections x External diameter of connection [mm]						
		3000	5000	7500	10000	12500	15000	20000
C-OU	Gas (G)	1 x 22	1 x 22	1 x 22	2 x 22	2 x 22	2 x 22	3 x 22
	Liquid (L)	1 x 18	1 x 18	1 x 18	2 x 18	2 x 18	2 x 18	3 x 18
B-OU	Gas (G)	2 X 22	2 X 22	2 X 22	3 X 22	4 X 22	4 X 22	5 X 22
	Liquid (L)	2 X 18	2 X 18	2 X 18	3 X 18	4 X 18	4 X 18	5 X 18
E-OU	Gas (G)	2 X 16	2 X 22	2 X 22	2 x 22	3 X 22	2 x 22	3 x 22
	Liquid (L)	2 X 12	2 X 18	2 X 18	2 x 18	3 X 18	2 x 18	3 x 18

The cooling circuits must be sized referring to the documentation on the Mr Slim units.

### 2.2.5 Hydraulic connection

The following requirements apply to all the hydraulic circuits connected to the unit, both on the user side and to other parts of the system.

The connecting pipes must be adequately supported to prevent them from weighing on the unit and to avoid subsidence of the pipes themselves and the formation of pockets of air that could obstruct the outflow. Avoid rigid connections between the machine and the pipes, and install vibration dampers.

For temperatures, minimum and maximum water flow rates and the content of water in the heat exchanger hydraulic circuit refer to the unit bulletin or ask the supplier. These indications must be respected both when the unit is working and when it is switched off. Protect the hydraulic circuit with an anti-freeze mix when the room temperature can drop below zero or eliminate all the water in the exchangers and in the lowest points of the hydraulic circuit.

Any heating elements installed to prevent the pipes from freezing must be kept away from devices, sensors and materials that the heating elements could damage or cause to malfunction (for example, temperature sensors, plastic components and power cables).

The temperature of the fluid at the machine outlet must always respect, even during the start-up phase, the work field envisaged by the manufacturer. For that purpose a by-pass valve and/or other system devices can be inserted on the hydraulic circuit.

The water system of the units must be designed in such a way as to guarantee that, in all working conditions, the fluid circulating in the primary circuit remains within the minimum limit set down in the technical bulletin of the unit.

If the unit is not equipped with a device for controlling the flow of vector fluid, it is necessary to guarantee that this is kept constant. The vector fluid must never flow backwards in the water circuits. This could damage the pumps and cause bypassing, compromising the capacity and temperature of the plant.

When several machines are installed in parallel, it will be necessary to:

- prevent the flow in the opposite direction, particularly when the machines are switched off. For this purpose, non-return valves or other suitable devices can be installed in the water circuit on the delivery side of the pumps or machines. Units equipped with several separate pumps installed in parallel include non-return valves on the delivery side of the pumps for this purpose. It is important to note that this does not apply to twin pumps;
- reduce the overall flow and shut off the flow to machines that are turned off in order to prevent mixing of fluids at different temperatures that can affect performance and the operating limits.

### 2.2.6 Hydraulic circuit sizing

#### Hydraulic connection of the condensate drain

To connect the condensate drain, follow the instructions below both for the WIZARDX unit and for the humidification section accessory.

#### Standard supply

The condensate drain pipe is connected to the collection tank.

The piping is at the bottom of the machine.

The condensate drain has a 1" male threaded sleeve for connection to the trap.

#### The condensate drains by gravity.

#### To be done by the installer

Set up a trap in the vicinity of the machine, as shown in the figure.

The trap prevents the intake of air from the drain pipe by eliminating the vacuum of the fan.

Connect the condensate drain to a rainwater drain pipe.

Ensure a 2 - 3% gradient of the pipe down towards the drain.

Keep the same internal diameter for drain pipes of up to 4 - 5 metres. For greater lengths, increase the section of the drain.

Insulate the pipes and the trap to prevent the dripping of condensation and the danger that the condensation will freeze.

Fill the trap with water.

**ATTENTION:**

Do not use washing or sewage water drains as this may cause unpleasant odours if the water in the syphon evaporates.

When done, check the condensate drains correctly by pouring some water into the drip tray.

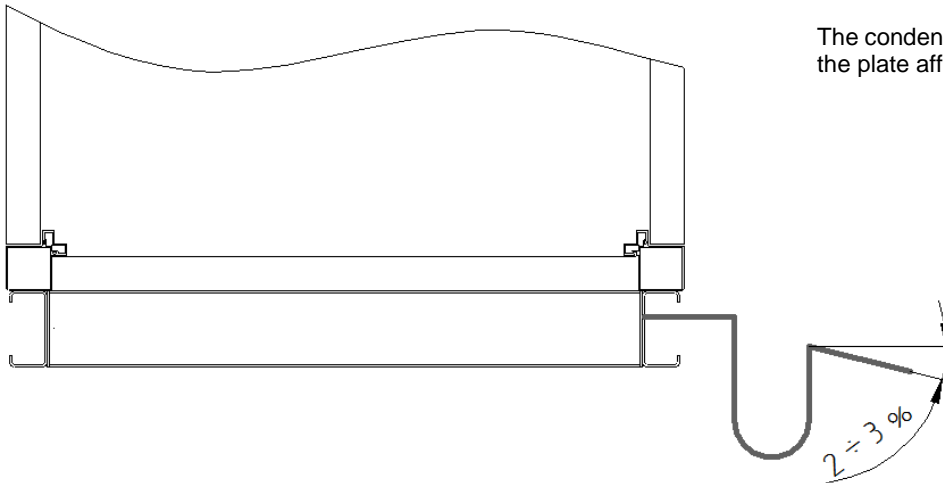

The condensate drain can be identified on the plate affixed directly on the machine.

**CAUTION:**

No part of the drain line should be uphill.

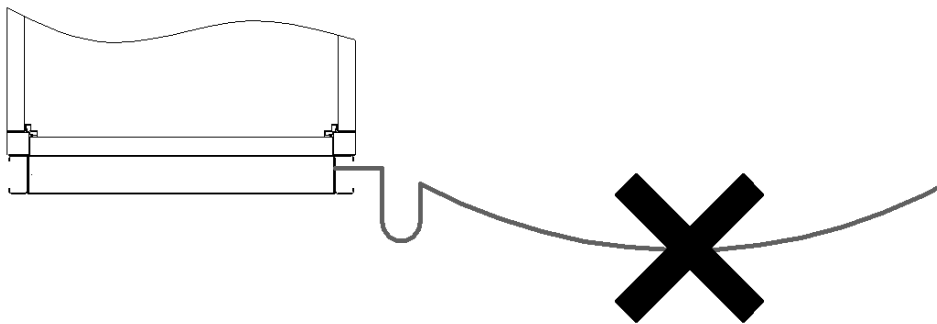

## 2.2.7 Hydraulic circuit connection

### Connection of the heat exchange coils

To prevent damage to the heat exchange coil at the connection point between the steel manifold and the copper circuit:

- When screwing the piping to the plant, turn the coil terminal in the opposite direction using pipe pliers.
- Install brackets to support the connecting pipes. The weight of the pipes must not in any way cause stress to the manifolds.

To optimise the heat exchange capacity of the coils:

- Wash them before connecting them to the network.
- Once properly installed, the air in the hydraulic circuit must be totally bled using the relative valves.

To allow the heat exchanger coil to be easily removed for maintenance:

- Network connections must be made in such a way as to allow the coil to be removed.
- On-off valves must be fitted to allow the coil to be disconnected from the hydraulic circuit.

In heating or cooling water coils normal heat exchange takes place in the opposite direction to the flow of treated air. Connect the pipes following the indications of the plates in the machine panel.

Install the coils with the piping horizontal.

The piping of the circuit must be sized in line with the flow rate indicated in the technical-commercial document, based on the machine size required for obtaining the design thermal performance.

As the piping must not weigh on the coil connector, fit suitable anchors and brackets.

To prevent damage to the coil caused by ice, fill the water circuit with antifreeze and totally drain the coil if the air temperature could fall below 4°C.

If the fan stops during the heating process, the air inside the unit may overheat and damage the motor, bearings, insulation and parts in synthetic material. In order to avoid such inconveniences, when installing a valve not supplied by MEHITS make sure to use the same signal generated by the MEHITS controller. If no valve is installed, the system must be set in such a way that the water flow stops when the fan is not running.



**CAUTION:**

Maximum operating pressure 10 BAR.

### 2.2.8 Cleaning and filling the hydraulic circuits



**CAUTION:**

Wash the pipes of the hydraulic circuits to remove any processing residues and other dirt inside. This operation must be performed to avoid damaging the parts of the machine. After washing, check the hydraulic circuits for any leaks. To do this, load the circuits at a pressure higher than atmospheric pressure and check that there are no pressure leaks over time.



**OBLIGATION:**

The thermal insulation of the pipes outside the machine is the responsibility of the installer and must only be completed after ascertaining that there are no leaks. Only use the intended products as indicated by the manufacturer.

### 2.2.9 Water quality

To guarantee the correct operation of the preheating coil and to avoid breaking of this or of the connected water circuit, the coil must be filled with a mixture of water and ethylene glycol, with a minimum weight percentage of ethylene glycol equal to 35%.

In the winter, empty the exchangers before periods of inactivity. When this is not possible and the external design temperature is less than 5 °C, it is necessary to protect the water circuits connected to the pre-heating coil and post-heating coil with a mixture of water and ethylene glycol, with a minimum weight percentage of ethylene glycol that is sufficient to prevent the mixture from freezing.

Contact the technical office to request information on the performance of the post-heating coil if it is filled with a mixture of water and glycol, specifying which type of glycol will be used.

Contact the technical office to request information on the performance of the pre-heating coil when it is filled with a type of glycol other than ethylene.

Check that the glycol used is compatible with the materials that make up the hydraulic circuit and the heat exchange coils.

Check that the water contained in the hydraulic circuit respects the following characteristics for the whole lifetime of the system:

	Description	Symbol	Value
1	Concentration of hydrogen ions	pH	7.5 ÷ 9
2	Presence of calcium (Ca) and magnesium (Mg)	Hardness	4 ÷ 8.5 °D
3	Chloride ions	Cl <sup>-</sup>	< 150 ppm
4	Iron ions	Fe <sup>3+</sup>	< 0.5 ppm
5	Manganese ions	Mn <sup>2+</sup>	< 0.05 ppm
6	Carbon dioxide	CO <sub>2</sub>	< 10 ppm
7	Hydrogen sulphide	H <sub>2</sub> S	< 50 ppb
8	Oxygen	O <sub>2</sub>	< 0.1 ppm
9	Chlorine	Cl <sub>2</sub>	< 0.5 ppm
10	Ammonia	NH <sub>3</sub>	< 0.5 ppm
11	ratio between carbonates and sulphates	HCO <sub>3</sub> <sup>-</sup> / SO <sub>4</sub> <sup>2-</sup>	> 1

Tab.4

where:  $1/1.78 \text{ °D} = 1 \text{ °Fr}$  with  $1 \text{ °Fr} = 10 \text{ gr CaCO}_3 / \text{m}^3$   
ppm = parts per million; ppb = parts per billion

### Explanatory notes

- Ref. 1: a greater concentration of hydrogen ions (pH) than 9 implies a high risk of deposits, whereas a lower pH than 7 implies a high risk of corrosion;
- Ref.2: The hardness measures the amount of Ca and Mg carbonate dissolved in the water with a temperature lower than 100 °C (temporary hardness).  
A high hardness implies a high risk of deposits;
- Ref. 3: the concentration of chloride ions with higher values than those indicated causes corrosion;
- Ref.4 - 5 - 8: the presence of iron and manganese ions and oxygen leads to corrosion;
- Ref. 6 - 7: carbon dioxide and hydrogen sulphide are impurities that promote corrosion;
- Ref. 9: Usually in water from the waterworks it is a value of between 0.2 and 0.3 ppm. High values cause corrosion;
- Ref.10: the presence of ammonia reinforces the oxidising power of oxygen;
- Ref. 11: Below the value shown in the table, there is a risk of corrosion due to the trigger of galvanic currents between copper and other less noble metals.

In the case of service fluids other than water (e.g. ethylene or propylene glycol), it is advisable to always use fluids containing special inhibitors that offer thermal stability within the operating temperature ranges and protection against corrosion phenomena.

It is absolutely essential that, in the presence of dirty and/or aggressive water, an intermediate heat exchanger is placed upstream of the refrigeration system heat exchangers.

The presence of air in the hydraulic circuit reduces the performance and can cause serious malfunctions and defects to the pumping system in particular. All the air must be released out of the air bleed valves of the unit and system and not allowed to enter again when setting up the hydraulic connection of the unit.

If the unit is to be put in storage for a long time, it is advisable to dry the heat exchangers and pressurise them with nitrogen to prevent humidity from lingering in the hydraulic circuit.

**CAUTION:**

The values indicated in the table must be guaranteed throughout the life cycle of the machine so as not to damage it.

### 2.2.10 Sizing and connection of the cooling circuits

**CAUTION:**

The designer of the plant is responsible for the precise sizing of the pipes in accordance with the speed of the fluid in the pipes as shown below

### 2.2.11 Compressor lubricant oil top up

**INFORMATION:**

The compressor plate shows the litres of oil introduced at the factory.

### 2.2.12 Safety valves and position and provisions of the drain piping

**CAUTION:**

The activation of the valve causes the discharge of pressurised and possibly hot coolant fluid. It is necessary to install a drain piping system, appropriately sized in accordance with current regulations, for the channelling of the coolant fluid to the outside.

### 2.2.13 Electrical connections

#### Power supply

The specifications of the mains power supply must comply with EN 60204-1 and the local regulations in force and be sufficient for the absorption requirements of the unit indicated in the wiring diagram and on the data plate. Mains voltage must correspond to the rated value +/- 10% with a maximum phase difference of 2%. The unit must be connection to a three-phase TN(S) type electric power supply. Should the installation of a circuit breaker be envisaged in the electrical system, it must be type A or B. Refer to local bylaws.

#### Power connections

Install an overload cut-out device, not included in the supply, on the supply line of the electrical panel in compliance with the regulations in force.

Supply the unit switchboard with a cable of a diameter suited to the absorption capacity of the machine indicated on the data plate. The control circuit is shunted off the power circuit from inside the electrical panel.

Do not touch hot and/or sharp surfaces. Do not lay electric cables unless their positions are specifically identified.

To ensure any anti-freeze heaters on the heat exchangers remain working, never disconnect the mains power supply except during maintenance operations.

**CAUTION:**

As regards the power supply of the Mr. Slim condensing units, a separate power supply must be provided on site for the WIZARDX units, following the instructions in the installation manual of the Mr. Slim condensing units. It is forbidden to connect Mr. Slim condensing units to the switchboard of the WIZARDX units.



## Control circuit interlocking

It is imperative to always check the wiring diagram before completing the connections: In the electrical panel are some cables and terminals, indicated in orange, that remain powered even with the power disconnector open (circuits excluded).

**In order for the guarantee to be valid:**

**the unit input connectors (remote ON/OFF, fire-fighting, etc.) must be clean and single contacts for each unit (never make a parallel connection to more than one machine with a single enable).**

**Below is an example of correct and incorrect connection.**

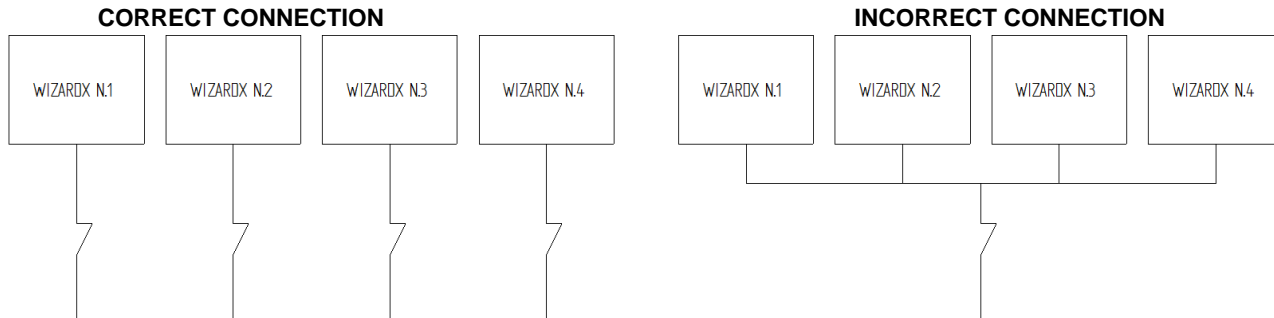

It is advisable to keep the power cables separate from the control cables. Otherwise, screened cables should be used. To make serial connections, use only screened cables with characteristic impedance of 120 ohm. The maximum length of the cable that connects safety devices to the farthest away unit must not exceed 1000 metres. **Input voltage phase difference.**

Do not operate the unit when the voltage phase difference is greater than 2%. Use the following formula to check:

$$\% \text{ difference} = \frac{\text{Max voltage difference from the average}}{\text{average voltage}} * 100$$

Example: rated mains voltage 400 - 3 - 50

AB = 409 V; BC = 398 V; AC 396 V

average voltage = (409 + 398 + 396) / 3 = 401 V

$$\% \text{ difference} = \frac{(409 - 401)}{401} * 100 = 1.99$$

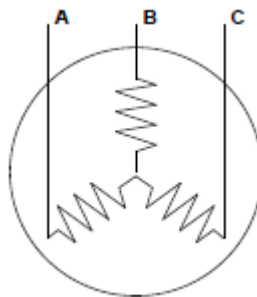

### INFORMATION:

If the mains voltage has a phase difference greater than 2%, contact the electricity company. If the unit is operated with a voltage phase difference of more than 2% THE GUARANTEE SHALL BE CONSIDERED NULL AND VOID.

Before starting up the unit, it is advisable to check that electrical systems have been implemented to guarantee conformity with the Electromagnetic Compatibility Directive (2014/30/EU).



## CHECKS AFTER MAKING THE ELECTRICAL CONNECTION

After making connections, make sure that:

The earth connection is efficient (use a suitable tool). An incorrect, inefficient or absent connection violates safety standards, is a source of danger and may damage machine components.

The direction of rotation of the motor is correct. If not, invert the connection of two wires on the input terminals.

The motor connections and current absorption values are correct.

Before start-up, check the connections between the circuit breaker and its bar, making sure that the protective pad at the end of the bar is in place.



## Signal connections

The Mr. Slim condensing units must be electrically connected to the WIZARDX units only by means of the cables required to send signals between the PAC-IF interface card and the Mr. Slim condensing units.

As in the case of the cooling circuits, it is also necessary to identify the exact circuit of reference for connection of the communication line between the PAC-IF interface card and the Mr. Slim condensing units.

The cables of the PAC-IF are connected to the terminal board; refer to the wiring diagram for the names of the cables.

Below is an example of an electrical connection:

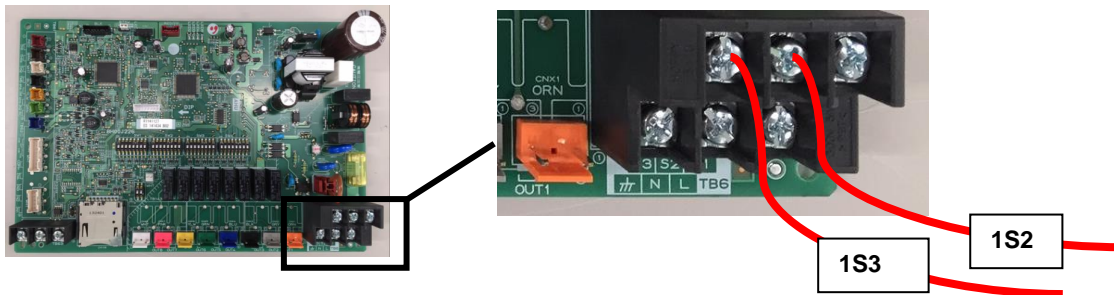

For the types of cables to be used and the connection procedures for the "S2" and S3" communication lines, refer to the installation manual of the Mr. Slim condensing units and the chapter "ELECTRICAL CONNECTIONS" in this manual.

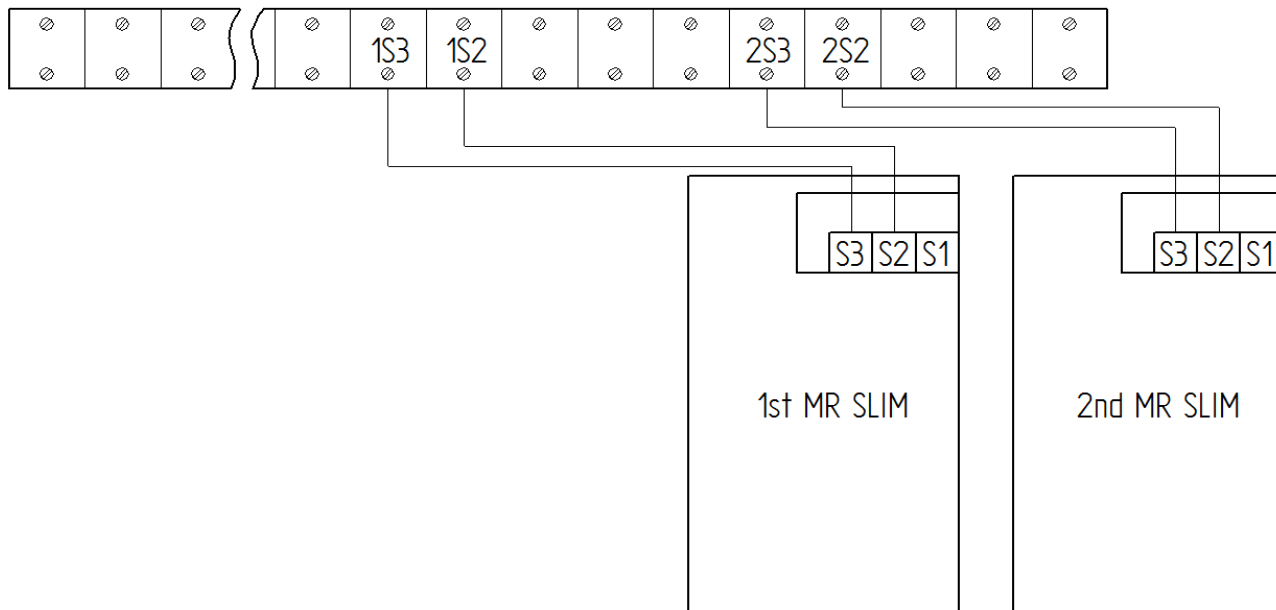
**INFORMATION:**

Incorrect connection of the signal cables between the PAC-IF interface card and the Mr. Slim condensing units can cause irreparable damage to, and malfunctioning of the connected machines.

The WIZARDX unit has a cable gland, as shown in the photo, for the signals described above.

**CAUTION:**

All electric work must be designed and performed by qualified personnel. Before proceeding, disconnect the power supply, making sure that no one will be able to accidentally reconnect it.

**CAUTION:**

The electricity power supply line must be fitted with a general switch for the disconnection of the machine from the energy source.

**CAUTION:**

Comply with the network polarity requirements.

### 2.2.14 Air connections

**PROHIBITION:**

It is forbidden to start up the WIZARDX unit unless the supply air outlet and the return air outlet are completely ducted or protected by a safety grille.  
It must not be possible to come into contact with the fans when these are running.

**The WIZARDX units are supplied with a protective mesh that prevents both intentional and unintentional contact with the fans. The protective mesh must not be removed.**

The WIZARDX units can be connected to the air ducts either directly by means of the aluminium profiles of its structure or by fixing the ducts to the dampers, if ordered.

We recommend the use of insulated channels to avoid energy losses and condensation.

In order to ensure proper connection with the ducts, the following should be done:

- Clean the contact surfaces between the duct and the unit.
- Fit an anti-vibration joint between the unit itself and the duct.
- Apply a gasket on the flanges to ensure their airtightness.
- Tighten the connecting screws carefully.
- Apply silicone on the gasket to increase the strength of the seal and make it watertight in the case that the unit is installed outdoors.
- Ensure the correct electrical potential between the ducts and the WIZARDX with an earth cable that acts as a bridge on the anti-vibration joint.
- For the ducting of the supply air outlet and the return air outlet, guarantee a straight section of at least one metre before making any bends or branches or putting in anything that could obstruct the air flow, to avoid reducing fan performance.
- After installation, the installed vibration dampers must not be taut as otherwise they could cause damage and the transmission of vibrations.
- Use appropriate brackets to support the ducts, in order to prevent these from weighing on the machine and to ensure that the connections do not come loose and that the structure of the machine remains intact.
- If the exhaust air expulsion port is not ducted, install a suitable rainproof hood to prevent the infiltration of water in the unit.
- If the fresh air expulsion port is not ducted, install a suitable rainproof hood to prevent the infiltration of water in the unit.
- Also install a hood to prevent the ingress of leaves or other dirt.

Flexible joints, dampers and rain covers may be supplied disassembled on pallets or inside the unit and then fixed to the module using the screws supplied, screwed into the inserts, in the position shown on the technical drawing and as per the example sequence shown below.

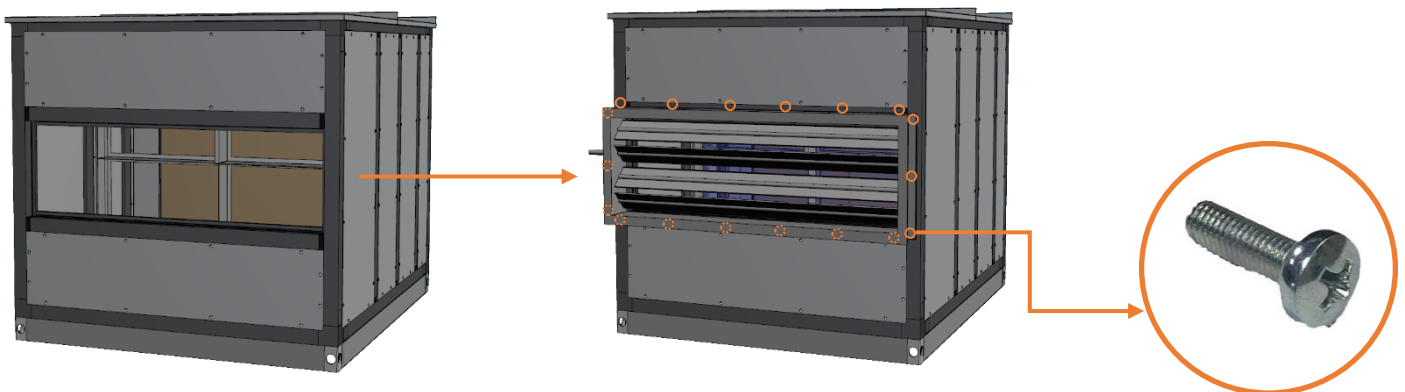

During normal operation of the unit, the rate of the air flow treated by the fans is sufficient to ensure that no hazardous mixtures can form inside the machine pursuant to the EN 378 standard as indicated in the table in chapter 2.2.1.2.

Units with R32 refrigerant charge are supplied as standard with delivery and return air dampers belonging to class CL4 according to the EN1751:2014 standard, and which close when the unit is not in operation.

In order to facilitate the disposal of refrigerant gas leaks during shutdown, the delivery damper is equipped with a **reverse-functioning vane, which must necessarily be excluded from the ducting.**

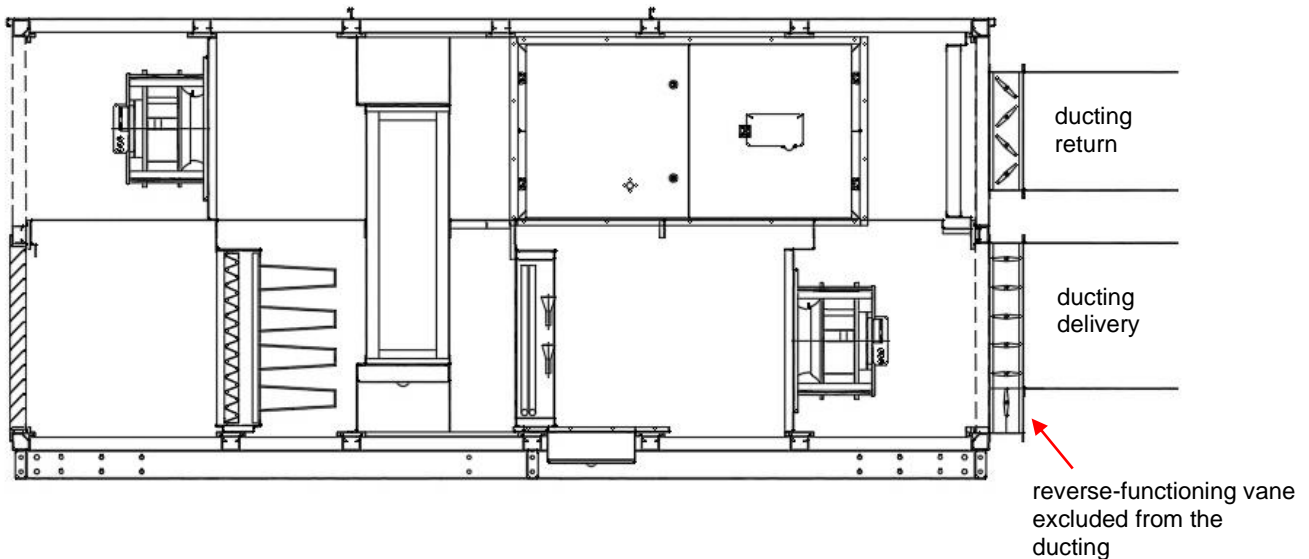

<p>Unit Status: ON</p> <ul style="list-style-type: none"> <li>• External air damper (optional): open</li> <li>• Ejection damper (optional): open</li> <li>• Return damper (standard): open</li> <li>• Delivery damper (standard): open</li> <li>• Reverse vane (gas disposal): closed</li> <li>• Ventilation: ON</li> <li>• Mr. Slim: ON</li> </ul>	<p>Unit Status: OFF</p> <ul style="list-style-type: none"> <li>• External air damper (optional): closed</li> <li>• Ejection damper (optional): closed</li> <li>• Return damper (standard): closed</li> <li>• Delivery damper (standard): closed</li> <li>• Reverse vane (gas disposal): open</li> <li>• Ventilation: OFF</li> <li>• Mr. Slim: OFF</li> </ul>

**Units operating with R32 can only be installed outdoors.**

It is strictly forbidden to install WIZARDX R32 air handling units in machine rooms or any other type of indoor space.



**CAUTION:**

If there is a loss of refrigerant, call technical assistance before restarting the machine.



**CAUTION:**

Avoid having the ducts putting weight on the machine or any components of the same (frames, panels, pipes, etc...).

## 2.2.15 Pressure drops on the air side of the ducts

The useful rated and maximum head values for the machine are indicated in the corresponding Technical Bulletin.



### CAUTION:

Duct pressure drops must be limited, as high values will cause an increase of fan power consumption.

## 2.2.16 Bms connection

Refer to the manual of the electronic controller of the unit.

# 3 START-UP STAGES

## 3.1 Before starting the unit

Before starting the unit (operation to be carried out by a MEHITS authorised support centre), the installer/customer must ensure that the following has been checked:

- Correctness of the electric connections.
- Absence of leaks in the cooling circuit.
- Compliance of hydraulic connections (if water coils installed).
- Hydraulic system liquid pressure and charge (if water coils installed).
- Operation of the pumping systems (if water coils installed).
- Power the unit for at least 8 hours before starting the machine, to make sure that the oil in the compressor sump is sufficiently hot.
- Open the fan compartment and check that no objects have been left that could damage the fans or other system components.
- Check that the air ducts are not obstructed (motor-driven fire dampers, manual dampers, etc.).
- Make sure that all differential pressure transducer connections have been completed (units with constant pressure ventilation control). The instructions can be found in paragraph 2.2.5 of this manual.
- Check that an appropriate condensation drain has been installed and that the procedure indicated in this manual has been completed (paragraph 2.2.4).
- Check that all protections have been removed from the finned pack exchangers, so that they can disperse heat correctly.
- Check the filters for cleanliness. Unfortunately, in some cases rooftop units are only switched on in ventilation mode long before the first start-up. This causes the filters to become dirty.

The Mr. Slim units and the WIZARDX unit must be properly positioned according to the instructions given in the respective manuals.

Access the electronic board of all the Mr. Slim units and set the dip switches according to the following indications (extract from the Mitsubishi Electric manual "Interface (Cased) PAC-IF013B-E PAC-SIF013B-E").

Outdoor unit DIP switch settings (when using separate interface unit/outdoor unit power supplies only)	ON			3	(SW8)
	OFF	1	2		

Set the SW8-3 to ON.

Below is the detail of the control board of a Mr. Slim unit with the DIP SWITCH SW8-3 in the position indicated in the aforementioned Mitsubishi Electric manual.

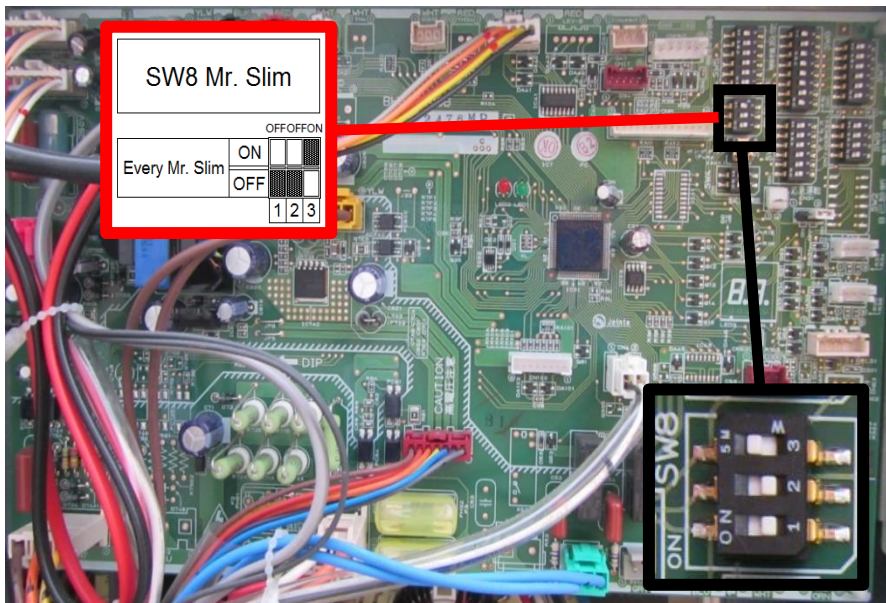

Each Mr. Slim unit must also be "addressed". Addressing is performed by positioning the DIP SWITCHES SW1 of the control board of the Mr. Slim unit as indicated below.

Mr. Slim address		SW 1			
<b>0</b>	1st Mr. Slim	ON			
		OFF			
			3	4	5
<b>1</b>	2nd Mr. Slim	ON			
		OFF			
			3	4	5
<b>2</b>	3rd Mr. Slim	ON			
		OFF			
			3	4	5
<b>3</b>	4th Mr. Slim	ON			
		OFF			
			3	4	5
<b>4</b>	5th Mr. Slim	ON			
		OFF			
			3	4	5

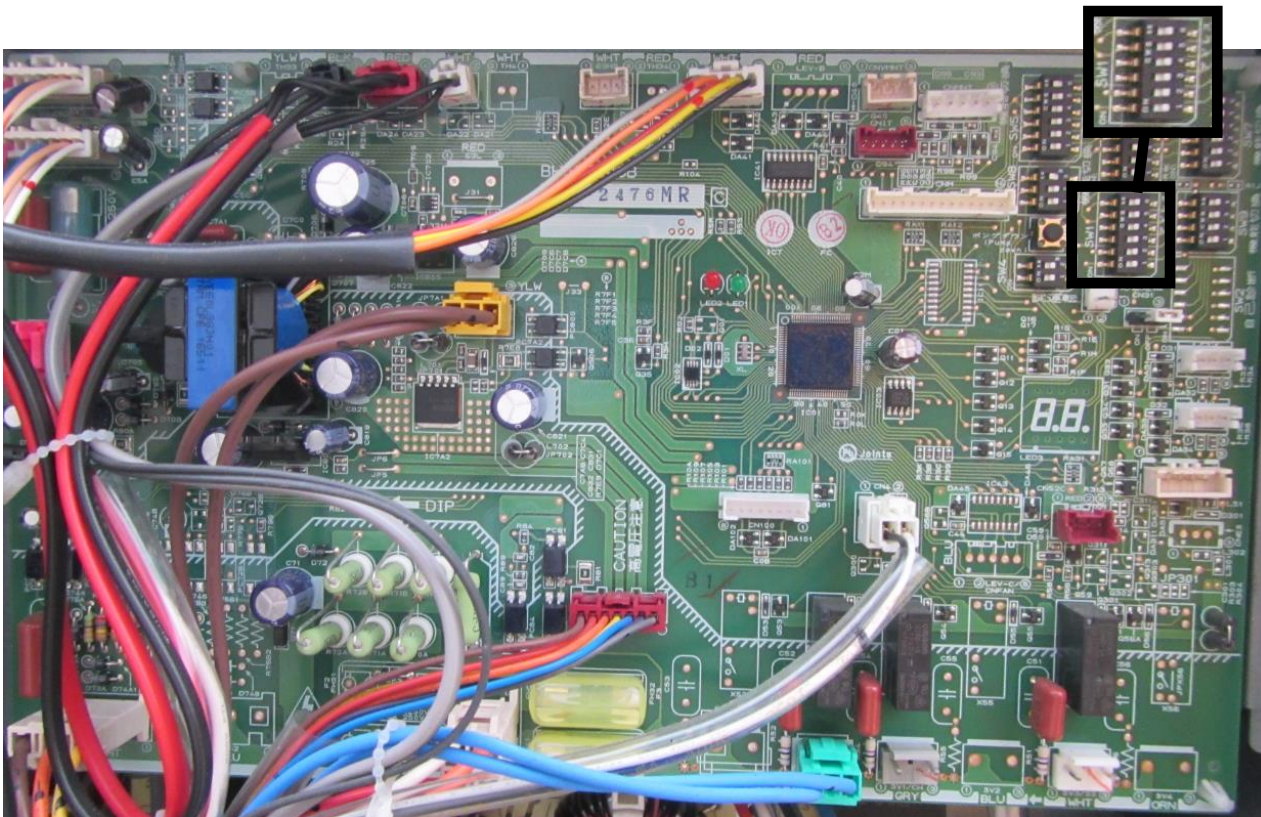

Refer to the documentation provided with the Mr. Slim units for further information.

Affix the adhesive label provided with the documentation in the WIZARDX unit on the individual Mr. Slim units (in the main section together with the technical documentation).

Avoid sticking the adhesive label on parts of the machine that can be accidentally put in a different place (the removable panels, for example).

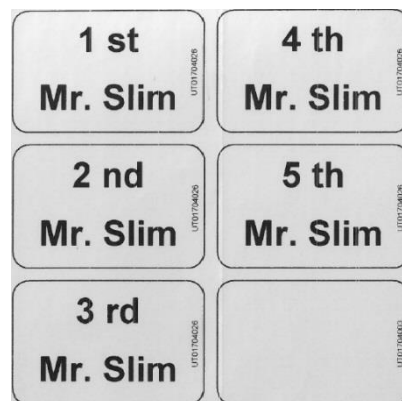

Connect the communication cable between the individual Mr. Slim units and the corresponding PAC-IF interface card as indicated in this manual.

The WIZARDX unit and the Mr. Slim units must be connected by means of the cooling circuits (refer to this manual and the manual of the Mr. Slim units).

A vacuum must be created in the cooling circuit according to the regulations in force and the instructions in the manual of the Mr. Slim units. Once the vacuum is created, open the valves on the Mr. Slim units.

The WIZARDX unit must be connected with suitable ducts to the room where the air is to be taken out or sent.

Electrically connect the Mr. Slim units and the WIZARDX unit independently with reference to their manuals.



See the illustrative diagram below (for making actual connections, refer to the wiring diagram on the machine). In the legend, the number of the circuit is indicated with "#".

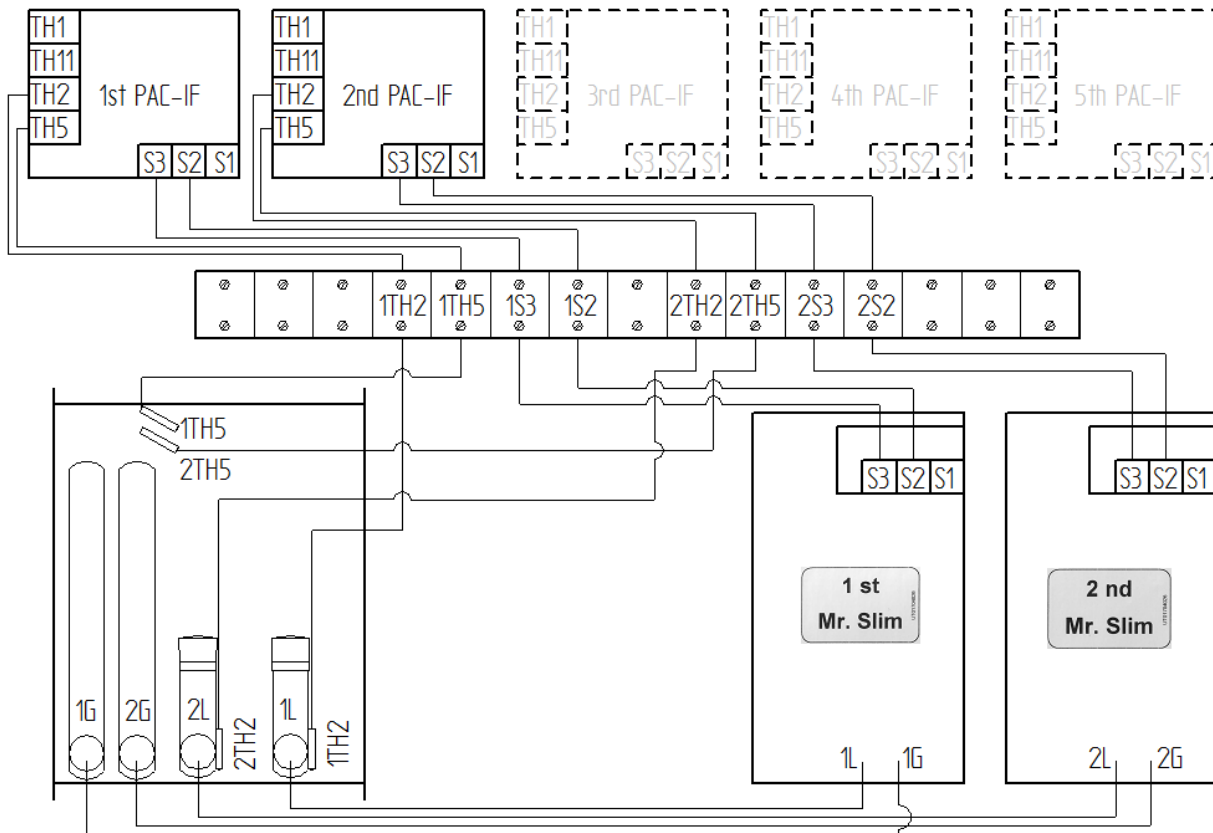

**Legend:**

"#"TH2: thermistor for the temperature of the refrigerant in its liquid state. It is located in the relative probe sump welded on the distributor of the exchanger

"#"TH5: thermistor for the temperature of the refrigerant in its two-phase state. It is located in the relative probe sump welded in an appropriate position on the circuit

"#"S2: signal connection between the PAC-IF interface card and the Mr. Slim condenser

"#"S3: signal connection between the PAC-IF interface card and the Mr. Slim condenser

"#"G: line of the refrigerant in its gaseous state

"#"L: line of the refrigerant in its liquid state

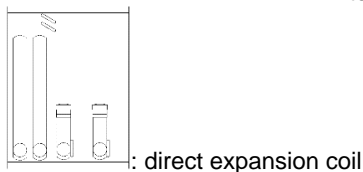
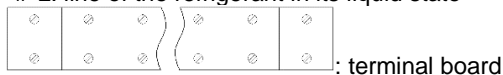

The WIZARDX unit is delivered with the TH2 and TH5 thermistors, which are required for correct operation of the unit, already in their probe sumps. It is forbidden to change the position the thermistors as to do so could affect correct operation and safety of the unit.

Open the inspection door to find the labels of the probe sumps. See the following image:



After doing the above, the technician entrusted with starting the machine can proceed with the software checks and then initial start-up.



#### INFORMATION:

The PAC-IF interface cards in the switchboard of the WIZARDX unit are addressed at the factory.

## 3.2 Machine start-up

Commissioning must be carried out by a specialist engineer, in the presence of the installer and an experienced operator. The specialist engineer will test the equipment, carrying out checks, calibrations and commissioning according to the applicable procedures falling under their responsibility.

The experienced operator must address questions to the specialist engineer in order to acquire the necessary information to be able to carry out the control and operation activities that will fall under their responsibility.

After the first few days of operation, check the mesh filters of the hydraulic circuits and clean as necessary.

MEHITS tests the cooling circuit for leaks after final assembly of the unit at the production site. An additional test must be carried out before start-up to check for leaks caused by faults created during transport or installation.

Check that the product and installation comply with the local regulations. In particular, make sure that the installation and commissioning certificates have been produced and communicated.

### 3.2.1 Calibration and tuning procedures

Refer to the manual of the electronic controller

### 3.2.2 Unit start-up

Before switching on the unit, check the condition of all the valves of the cooling circuit.

Make sure that the unit has been powered for **at least 8 hours**, so that the oil in the compressor sumps is sufficiently hot.

In case of phase monitor not installed, check that the direction of rotation of compressors and fans is correct.

Check that all heat exchangers are able to disperse heat (opening of fire dampers, removal of finned pack protections, etc.).

### 3.2.3 Adjustments and calibration

In case of unit with filter pressure switch, the latter must be calibrated.

The pressure switch must be calibrated based on the pressure drop caused not only by the level of soiling of the filter, but also the air flow rate.

The calibration must be completed as follows, with the filter clean:

- switch the unit on;
- gradually cover the air filter surface and check that the pressure switch triggers at an approximate level of cover of **50-60%**;
- if this does not happen, gradually lower the pressure switch calibration level;
- in case of immediate triggering, raise the calibration point.

Set the air flow based on the needs of the system, keeping this value within the flow rate range for that size of unit. Check the power consumptions, making sure that they are not near the point that will cause protections to activate.

## 4 USE AND MAINTENANCE

### 4.1 Method of use



#### CAUTION:

After turning off the power, wait at least 5 minutes before accessing the switchboard or any of the other electrical components.

Before accessing the switchboard, use a tester to check that there is no residual power.

The maintenance table indicates the operations which do not require switching off the WIZARDX unit.

#### 4.1.1 Description of controls

For the use of the control panel, refer to the software "user manual".

The "user manual" is supplied with the unit and is stored inside the electrical panel.

The following type of user interface is available:

**[ALARM key]**: displays the alarms and resets normal operating conditions. If it is on red, there is at least one alarm/notification active.

**[MENU key]**: accesses the main menu. It turns yellow when inside the menu.

**[ESC key]**: Goes back one level in the mask tree if you are in the header masks, or returns to the unit controller.



**[UP key]**: moves around the masks and sets control parameter values.

**[ENTER key]**: confirms entered data.

**[DOWN key]**: moves around the masks and sets control parameter values.

**Note:** Pressing "ESC + UP" at the same time switches between the user interface of the cooling part and that of the air-handling part.

**INFORMATION:**

- The back-lighting of the keypad turns off after 2 minutes when no buttons are pressed
- The back-lighting of the keypad flashes when the unit is in alarm mode and there is no interaction with the keypad

Key combinations activate a set of specific functions.

Key	Description
	<b>[MENU' + ALARM + UP keys]:</b> Increase screen contrast.
	<b>[MENU' + ALARM + DOWN keys]:</b> decrease screen contrast.
	<b>[ESC + ALARM keys]:</b> in the shared keypad mode, this combination shares screenshots and parameters among pLAN connected units.
	<b>[UP + DOWN + ENTER keys]:</b> press for 5 seconds to set the pLAN address on the user terminal.
	<b>[ALARM + UP keys]</b> with the user terminal set to 0, it configures the pLAN address on the control board

#### 4.1.2. Prolonged shutdowns of the machine

**CAUTION:****DANGER OF FREEZING.**

In case of machine stop during the winter period, take the necessary precautions to prevent the water inside the system from freezing.

Before a long period of inactivity:

- disconnect the power supply in order to avoid electrical risks or damage due to lightning;
- prevent the risk of freezing (empty the unit or add antifreeze liquid to the sections of the system exposed to negative temperatures; keep any antifreeze heaters running);

IT IS advisable that the start-up after the standstill period is performed by a qualified technician. During start-up, follow the instructions in the "COMMISSIONING" section.

Plan the work of the technician in advance in order to avoid any misunderstandings and to ensure that the system is ready when required.

#### 4.1.3 Start-up after extended machine inactivity

Start-up after a period of stop must always be supervised by a specialist technician with appropriate knowledge of the control, maintenance, calibration and start-up activities.

## 4.2 Maintenance instructions

### 4.2.1 General information



**CAUTION:**

All ordinary and extraordinary maintenance activities must be carried out by specialist personnel appointed by the manufacturer or its authorised representative.

Maintenance operations are fundamental to keep the refrigeration system in perfect working order, not only for purely functional reasons, but also to save energy and ensure safety.

Maintenance activities may only be carried out by personnel with the necessary qualifications in accordance with the local laws in force. It is also reminded that in Europe it is mandatory to comply with EU Regulation 517/2014 (F-Gas) on the prevention of emissions of fluorinated greenhouse gases.

When there are no relevant standards on the use of HFO refrigerants, the Manufacturer requires application and compliance with the provisions of:

- (EC) regulation no. 842/2006, Article 3 on "containment of leaks".
- (EC) regulation no. 1516/2007 on "standard leakage checking requirements".

and the relative domestic laws implementing the European regulations listed above.

Before any kind of maintenance is carried out the following measures must be observed:

- operate with the electrical panel closed;
- the unit must be isolated from the electricity mains using the external main switch, suitable for the insertion of up to 3 padlocks, for locking in the "open" position;
- place a sign saying, "Do not operate - maintenance in progress" on the disconnecting switch open;
- use the appropriate personal protective equipment (hard hat, insulated gloves, protective glasses, safety footwear, etc.);
- equip yourself with tools in good condition and make sure you fully understand the instructions before using them;
- in case of units with R32, take appropriate measures to ensure sufficient airflow into the room (using an external fan or opening windows) to avoid R32 concentrations exceeding the limit;
- in the case of units with R32, check for leaks using a suitable device before starting any operation;
- make sure that there are no flammable materials or possible sources of ignition in the proximity of the work area;
- make sure that fire-fighting systems are in place in the vicinity of the machine.

Whenever measurements must be taken or checks performed with the machine running, it is necessary to:

- make sure that any remote control systems are disconnected. Keep in mind, however, that the PLC on board the machine controls their functions and can activate and deactivate the components, creating dangerous situations (such as for example powering fans and their mechanical drive systems);
- make sure that no one is inside the unit;
- make sure that no objects or tools are left inside the unit;
- make sure that all the inspection doors of the unit are closed;
- for external units, do not work on the machine in adverse weather conditions such as rain, snow, fog, etc.

Furthermore, the following precautions must always be taken:

- the cooling circuit contains pressurized refrigerant gas. All operations must be carried out by qualified personnel with the authorisations or certifications required by the laws in force;
- never disperse the fluids contained in the refrigeration circuit to the environment;
- never keep the cooling circuit open, as the oil absorbs humidity and deteriorates;
- during venting operations, protect against possible fluid leaks at dangerous temperatures and / or pressures;
- when replacing electronic components, always use tools suitable for the task (extractors, anti-static bracelet, etc.);
- if replacing a motor, compressor, evaporator, condensation batteries or any other heavy component, make sure that the lifting mechanism is suitable for the weight to be lifted;

- before generating a vacuum in the cooling circuit, make sure to disconnect from the power supply all the phases of the electric motor of the compressors by removing or disconnecting the electrical protections (fuses and/or automatic switch) upstream of the cooling circuit. After charging with refrigerant, put the protections back in place with the power turned off before start-up;
- do not access the fan compartment without first isolating the machine using the main switch on the panel and displaying a "Maintenance - do not switch on" sign;
- contact MEHITS whenever modifications must be made to the cooling circuit, hydraulic or electrical diagrams of the unit, or its control logic;
- contact MEHITS whenever particularly complicated disassembly or re-assembly operations need to be performed;
- only use original spare parts purchased directly from MEHITS or from official dealers;
- contact MEHITS if you wish to move the unit over a year from installation or when dismantling becomes necessary;
- make sure that all tools, electrical cables or loose objects have been removed and that the machine has been connected perfectly before closing and starting the unit again;
- it is not permitted to walk on or place objects on the units. Any maintenance on the roof must be carried out using suitable equipment to guarantee safety (for example bridging access platforms);
- some maintenance operations in the unit pose the risk of trapping. Appropriate precautions must be taken.

#### 4.2.2 Scheduled maintenance



##### INFORMATION:

Failure to carry out regular maintenance will make the warranty null and void and relieve the manufacturer of all safety related responsibilities.

The frequency of maintenance operations depends on the type of use to which the unit is put. Frequent maintenance drastically reduces the occurrence of faults and downtime caused as a result.

#### Machine booklet

Provide a machine booklet for keeping a record of the maintenance work carried out on the unit. In this way, it will be easier to properly plan maintenance work and any fault finding. Put these details in the booklet:

- date;
- operation performed;
- description of operation;
- measurements carried out, etc.

#### 4.2.3 Table of general maintenance jobs

	Recommended periodic maintenance interventions					
	Operation description	Frequency*				operating hours
		3/4 months	6 months	12 months	24 months	
general	Tighten the electrical connections and replace any worn or damaged cables	•				
	Check for any leaks on the cooling circuit. Perform this operation at the frequencies indicated in the relative European regulations	•				
	Check the unit power supply voltages	•				
	Check the compressor power supply voltages	•				
	Check the fan power supply voltages	•				

	Check the operation of exchanger and/or pipe anti-freeze resistances (where fitted)	•				
	Check the operation of solenoid valves	•				
	Check the operation and calibration of minimum and maximum safety pressure switches (where fitted)	•				
	Clean the safety valve drains			•		
	Replace and calibrate safety valves (in accordance with the European regulations of reference)				•	
	Check the pressure probe reading, calibration	•				
	Check and if necessary replace dehydrator filters on the liquid line			•		
	Check the condition of hoses (where fitted)	•				
	Check the wear on the compressor contacts	•				
	Check the wear on the fan contacts			•		
	Check the noise level of the fan bearings	•				
	Clean/replace Rooftop unit filters	•				
	Clean the condensing coils (preferably from the inside to the outside); see par. 4.2.4 / 4.2.5.			•		
	Check for any liquid leaks	•				
	Check the horizontal positioning of the unit			•		
	Check for rust on the cooling circuit, especially the pressure vessels. Apply appropriate surface protection if necessary			•		
	General unit cleaning			•		
	Check the conditions of the enthalpy wheel			•		
	Vent the water circuit and heat exchangers (the combination of fluid and air reduces performance and can cause corrosion)					
Cooling circuit, unit operation on full load	Measure overheating temperature value			•		
	Measure overcooling temperature value			•		
	Measure compressor discharge gas temperature value			•		
	Measure low pressure value			•		
	Measure high pressure value			•		
	Measure fan absorption, 3 phases (L1, L2, L3) or single phase where single-phase fans present			•		
	Measure compressor absorption, 3 phases (L1, L2, L3)			•		
	Measure outdoor air temperature			•		

	Check the flow of water to the exchangers (where fitted)	•				
	Measure the temperature of the input and output water of the exchangers (where fitted)		•			
	Check oil level	•				
<b>Compressor</b>	Check the acidity, humidity, pressure and temperature of the oil sump			•		
	Check the filter and clean the oil			•		
	Replace oil check correct operation of compressor oil case resistance					Scroll compressor: 12000 hours

\* The frequency of the operations described in the table above should be considered indicative. In fact, it may undergo variations according to the method of use of the unit and the system in which the latter is required to operate. Just think of the frequency of filter replacement. Fouling is obviously affected by the quality of the treated air.

### Structure

Check the condition of the structure of the unit.

Treat with paints designed to eliminate or reduce oxidation those points of the unit where the problem can occur.

Check the fastening of the external panelling of the unit. Loose fasteners may cause abnormal noise and vibration.

### Internal air coil and drip tray

Accidental contact with the fins of the heat exchanger can cause physical injury. Take all the necessary precautions and wear suitable protective gloves.

The finned surfaces of the cooling coils and the drip trays in particular are places where microorganisms and mould can proliferate.

Clean with suitable cleaning products on a regular basis and perform disinfection with sanitising products if necessary.

Accumulated dirt can cause clogging that prevents the correct flow of the condensate.

### Filters

In the interest of ensuring the high performance and energy efficiency of the air handling unit, there must be a differential pressure switch for each filtering section of the control system of the WIZARDX units that can trigger an alarm when the drop in pressure at the filter exceeds the maximum permitted value. This alarm appears on the user interface terminal.

#### **EPM1 50% - ISO 16890 (F7 - EN 779:2012) rigid bag filters (standard), activated carbon rigid bag filters or EPM1 85% - ISO 16890 (F9 - EN 779:2012) rigid bag filters (both available as optional accessories)**

Pocket filters cannot be refurbished. Once dirty, they must always be replaced.

1. open the access panel;
2. take the filters out with care to avoid spreading dirt in the area below;
3. insert the new filters, fitting them in the same direction as those that were just removed;
4. close the panel;
5. send the old filters to a specialised collection or recycling centre (comply with the regulations in force).

#### **ISO COARSE 55% - ISO 16890 (G4 - EN 779:2012) synthetic pleated air filters**

It is essential that the air handling coil is able to offer maximum heat transfer. The unit must therefore always be operated with the air filters installed and the filters must be kept in proper condition.

Cleaning and replacing the filters when necessary is essential not only for practical reasons but are also very important from the point of view of health and hygiene.

Clogged filters can reduce the air flow rate and, therefore, cause malfunctions and blockages as well as breaking of the unit and downtime.

The frequency at which to check the filters depends on the quality of the supply of air from outside, the hours of operation of the unit, the level of dust and the number of people in the rooms.



In general, the optimal frequency can range from once every 15 days to once every 2 months. It is advisable to start with frequent checks, and then adjust the frequency based on the level of fouling detected.  
Follow the procedure below:

1. open the access panel;
2. take the filters out with care to avoid spreading dirt in the area below;
3. wash the filter mat in lukewarm water with a common detergent;
4. rinse thoroughly in running water avoiding dispersal in the environment;
5. dry the filter;
6. put it back in its place;
7. reassemble the closing panels.

Old filters, wastewater and residues must be disposed of according to the regulations in force.

### Steam humidifier

Regular checks.

#### • After one hour of operation

In the case of both disposable cylinders and openable cylinders, check for any significant water leaks.

#### • Every 15 days and after no more than the first 300 operating hours

In the case of both disposable cylinders and openable cylinders, check operation and for any significant water leaks, and assess the general condition of the container. Check that arcs or sparks are not generated between the electrodes during operation.

#### • Quarterly and after no more than 1000 operating hours

In the case of disposable cylinders, check operation and for any significant water leaks, and replace the cylinder if necessary. In the case of cylinders that can be opened, check for any significantly blackened areas on the container. If so, check the electrodes for fouling and replace them as necessary, together with the sealing O-rings and the cover gasket.

#### • Annually and after no more than 2500 operating hours

Replace any disposable cylinders. Check the operation of cylinders that can be opened, if there are significant air leaks, the general condition of the container, any noticeable blackened areas of the container. Replace the electrodes, together with the sealing O-rings and the cover gasket.

#### • After five years and after no more than 10,000 operating hours

In the case of both disposable cylinders and openable cylinders, replace the entire cylinder.

Refer to the manual of the steam humidifier supplied with the unit for further information.

### Electric heaters (optional component)

Check:

- The level of cleanliness.
- Correct fastening.
- For any signs of corrosion.

### Rotary exchanger

- Rotor maintenance.

The space around the heat exchanger affects operation, efficiency and pressure drop. The main parts of the heat exchanger should be checked regularly, especially when air quality is poor. This simply involves carrying out periodical visual inspections.

The rotor must be checked regularly to prevent build up of dust and dirt. Even if the air handling unit is installed with filters, these may break, allowing dirt to enter and block the rotor.





If dust and dirt build up on the rotor, these can easily be removed as follows:

- Vacuum cleaner, for small amounts of dry dirt.
  - Compressed air, in case of significant dry deposits. Make sure not to damage the rotor.
  - Pressure washer with hot water (max 70°C) or detergent spray (e.g. Decade, ND-150, Chem Zyme, Primasept, Poly-Det, Oakite 86M or the like) to remove grease or significant amounts of damp dirt.
- Avoid using strongly alkaline or other corrosive substances to clean the rotor.

- The minimum distance of the spray nozzle from the rotor must not be less than 30 cm, with a maximum pressure of 50 bars (i.e. Kärcher pressure washer).
  - The detergent used must be delicate (not strongly alkaline or acidic so as to not react with the aluminium)
  - After cleaning, blow out any water that may have settled on the rotor.
  - When cleaning, make sure not to damage the heat exchanger mechanically or chemically.
- **Drive maintenance**

The rotor is driven by a motor via a belt that runs around the rotor. Drive belt tension must be checked after the first 100 operating hours. Tension can be increased by shortening the belt.

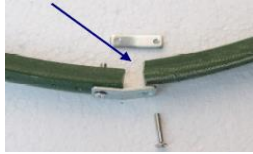
The motor itself does not require maintenance.

<b>Belt</b>	
<p>The "V" belt is fixed via a connecting clamp (photo on the right). Make sure that the belt is long enough to allow rotation to be transmitted without slipping. Regularly check that the belt is intact when the wheel is stationary.</p>	
<b>Belt replacement</b>	
<p>Open the connecting clamp and pull the old belt off the pulley. Check that one end of the new belt is cut at one of the holes, otherwise cut it accordingly.</p>	
<p>Position the new belt around the rotor, pull it tightly and cut it at the required length.</p>	
<p>Secure with the other end of the connection clamp, inserting the pins in the holes and tightening them. Attach the belt to the motor pulley and remove the old belt from the rotor.</p> <p>Finally, check that the belt is correctly tensioned before starting the rotor again.</p> <p>The same operation can be carried out for re-tensioning the belt after 100 operating hours.</p>	

- **Maintenance of the gasket between rotor and frame**

The gap between the gaskets and the rotor must be checked during the inspection and corrected if necessary. The gaskets do not require further maintenance.



- **Brushes**

The nylon brushes fitted on the rotors have a cleaning and insulating function on both air flows. Regularly check that the brushes are intact when the rotor is off.

If there is wear, they should be adjusted or replaced.

Eyelets (photo B) are provided on the inside guide of the brushes for adjusting the distance between the motor and the guard side.



(photo B)

- **Brush replacement**

Loosen the screws fixing the brush gasket and on the rotor. Remove the brushes from the enthalpy wheel and then replace them with the same type of spare brushes, ensuring correct tightness to prevent slipping. Tighten the fixing screws. The adjustment must ensure no friction between the two parts.

#### 4.2.4 Extraordinary maintenance



**ATTENTION:**

Failure to comply with the above will make the warranty null and void and relieve the manufacturer of all safety related responsibilities.

#### Checking the readings of the probes/positioning of the probes

Legend:

- #: number of the circuit of reference
- 4KF6: Mitsubishi Electric remote controller
- 7KF1: controller of the WIZARDX unit
- PAC-IF for circuit #
- 7BT4: supply air temperature probe
- 7BT5: return air temperature probe
- 8BP1: Supply differential pressure probe
- 8BP2: Return differential pressure probe
- 8BT6: External air probe
- 8BT8: Recuperator outlet air temperature probe (only for versions E-OU and B-OU)
- #TH1: Temperature probe (only for version C-OU)
- #TH2: Liquid temperature probe of circuit #
- #TH5: Two-phase temperature probe of circuit #
- #TH11: Air handling coil inlet temperature probe

----- ■ In red (and "full" rectangle), the temperature control probe

- E.A.: Exhaust air
- O.A.: Outdoor air
- S.A.: Supply air
- R.A.: Return air

#### Accessories:

- 7BT1: CO<sub>2</sub> probe
- 7BT2: supply air humidity probe (only for version B-OU or when the steam humidification section accessory is present)
- 7BT3: return air humidity probe (only for version B-OU or when the steam humidification section accessory is present)
- 8BT7: Antifreeze sensor (only available with the accessories: electric pre-heating coil, water pre-heating coil, water post-heating coil. If only the post-heating coil is present, the probe will be positioned downstream of the coil itself.)

#### Positioning of the probes for the C-OU version with control on the supply line

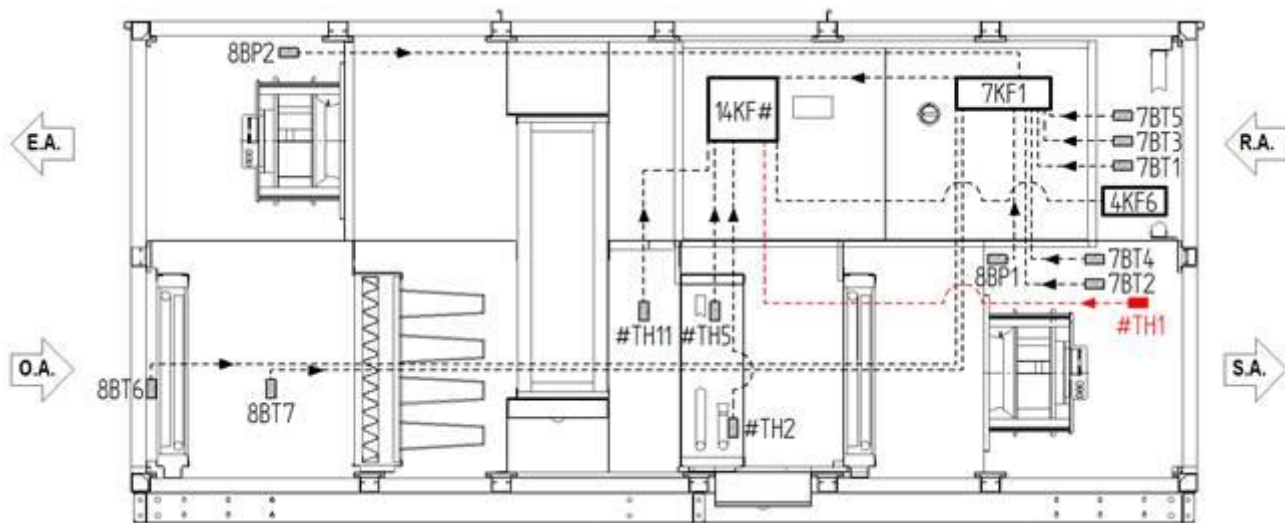

#### Positioning of the probes for the C-OU version with control on the return line

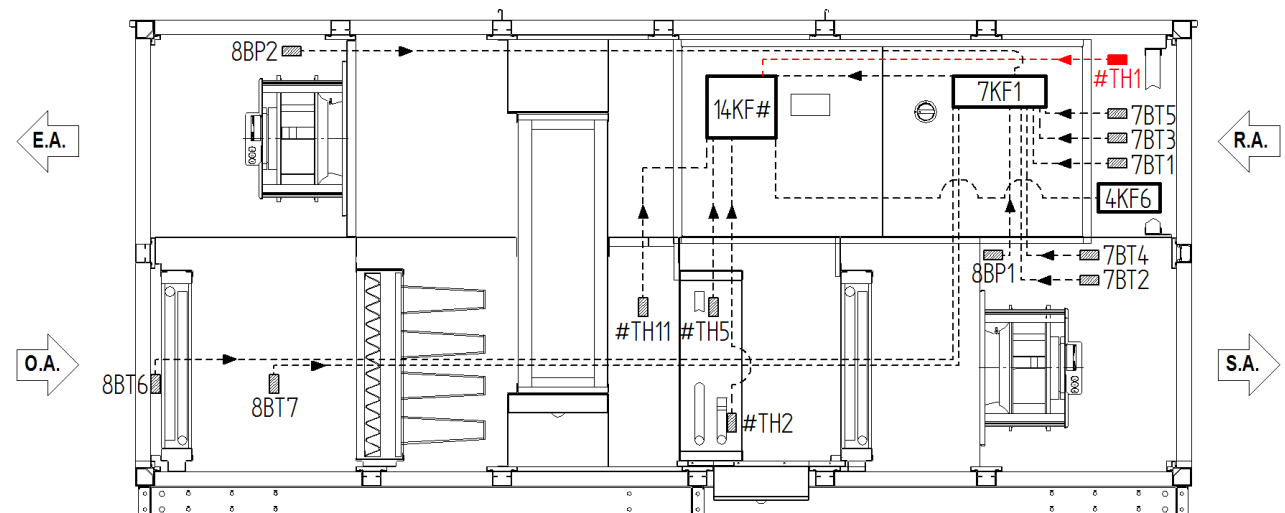

**Positioning of the probes for the E-OU and B-OU versions with control on the supply line**

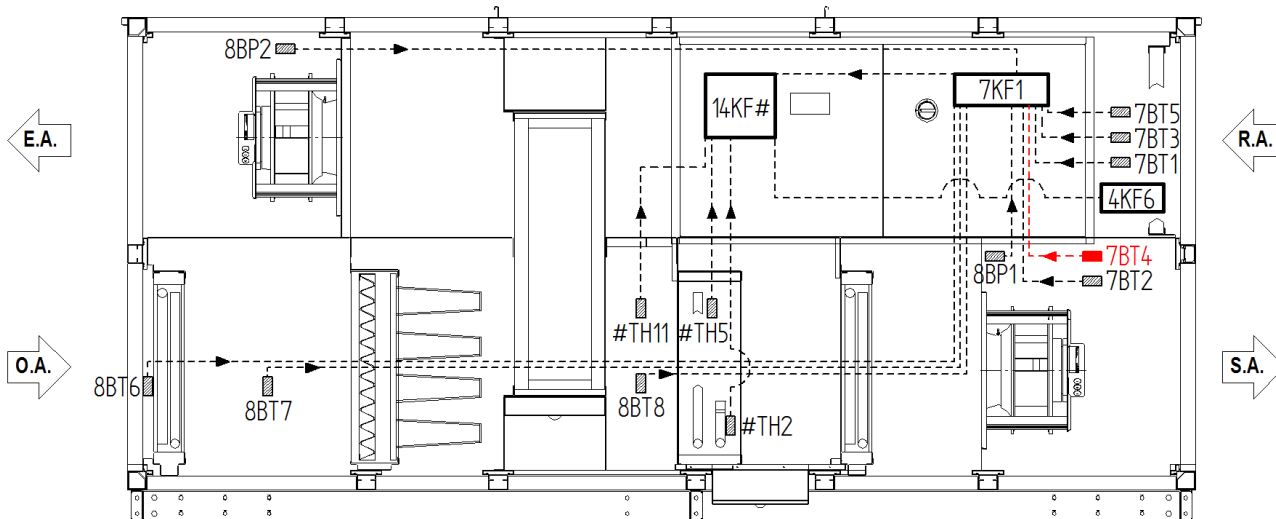

**Positioning of the probes for the E-OU and B-OU versions with control on the return line**

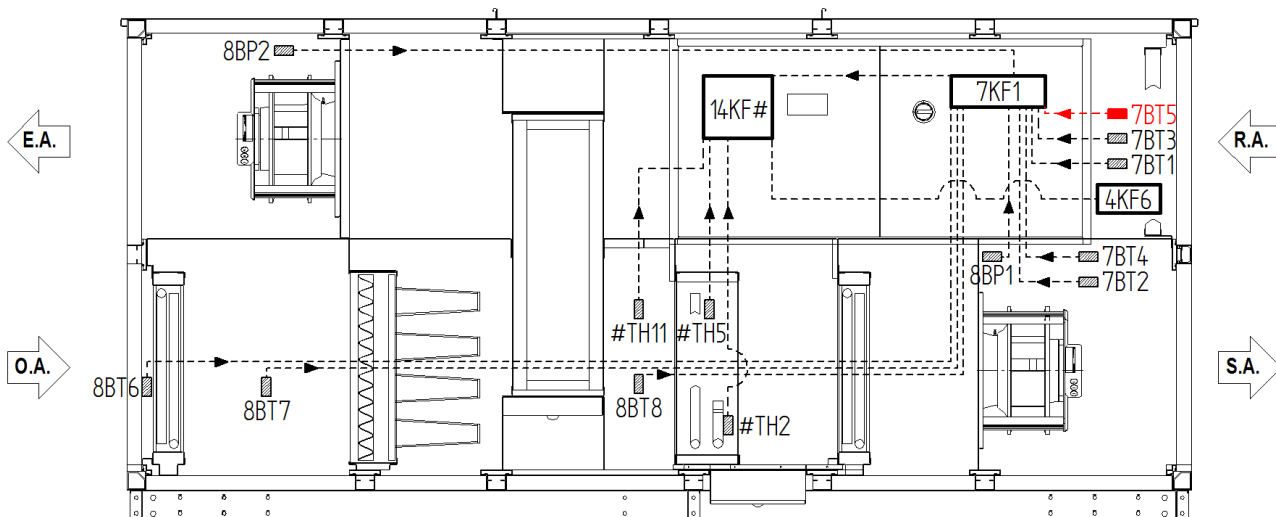

Positioning of the probes for the C-OU version with control on the supply line

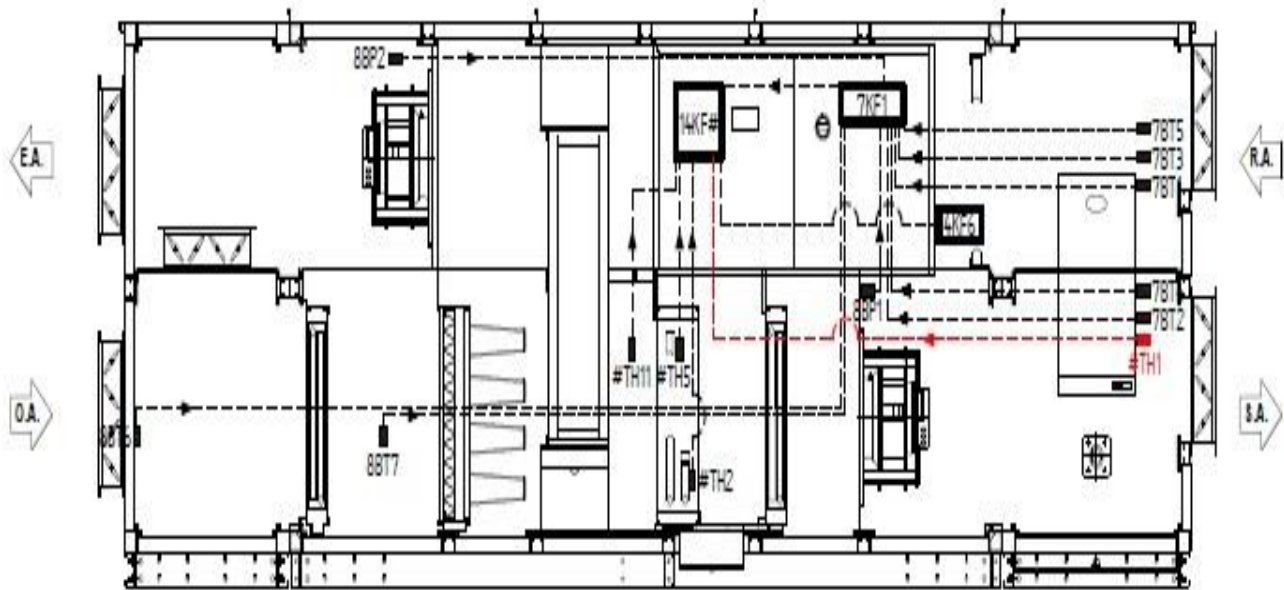

Positioning of the probes for the C-OU version with control on the return line

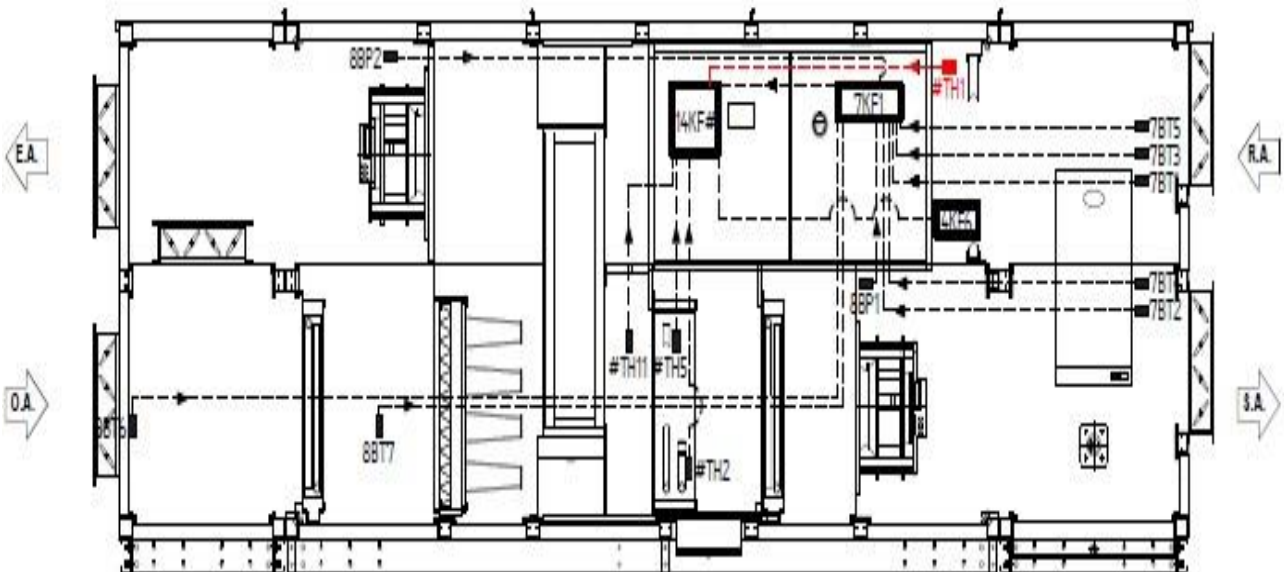

Positioning of the probes for the E-OU and B-OU versions with control on the supply line

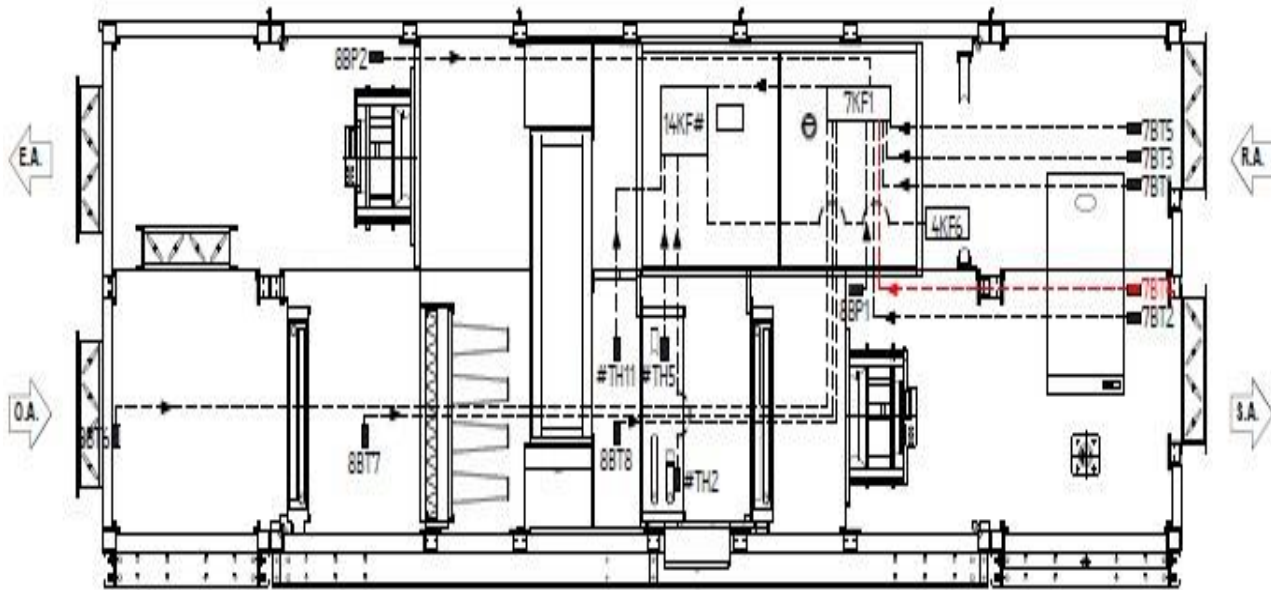

Positioning of the probes for the E-OU and B-OU versions with control on the return line

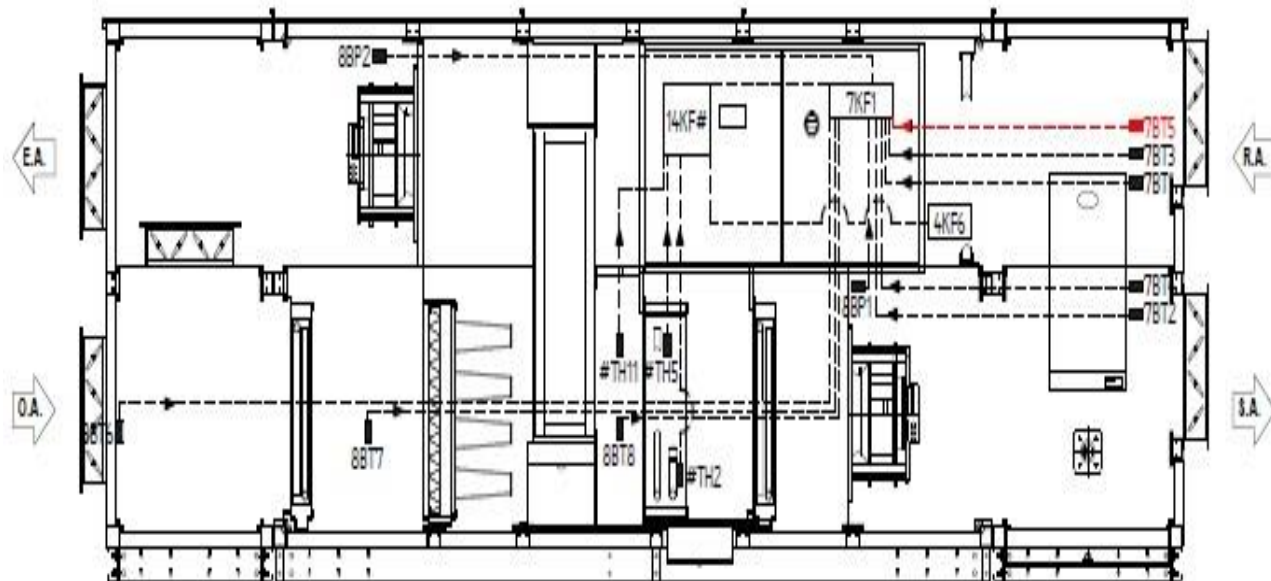

## Replacement of the PAC-IF interface cards

### C-OU version

If the card is faulty and needs to be replaced, make all the electrical connections as on the original card.

Make sure to also set the DIP SWITCHES on the new PAC-IF interface card as illustrated below.

The DIP SWITCHES of the SW1, SW2, SW3, SW6 must be set in the same way for all the PAC-IF interface cards in the switchboard of the WIZARDX unit.



#### INFORMATION:

The DIP SWITCH SW1-7 must be set at:  
 OFF if control is on the supply line  
 ON if control is on the return line

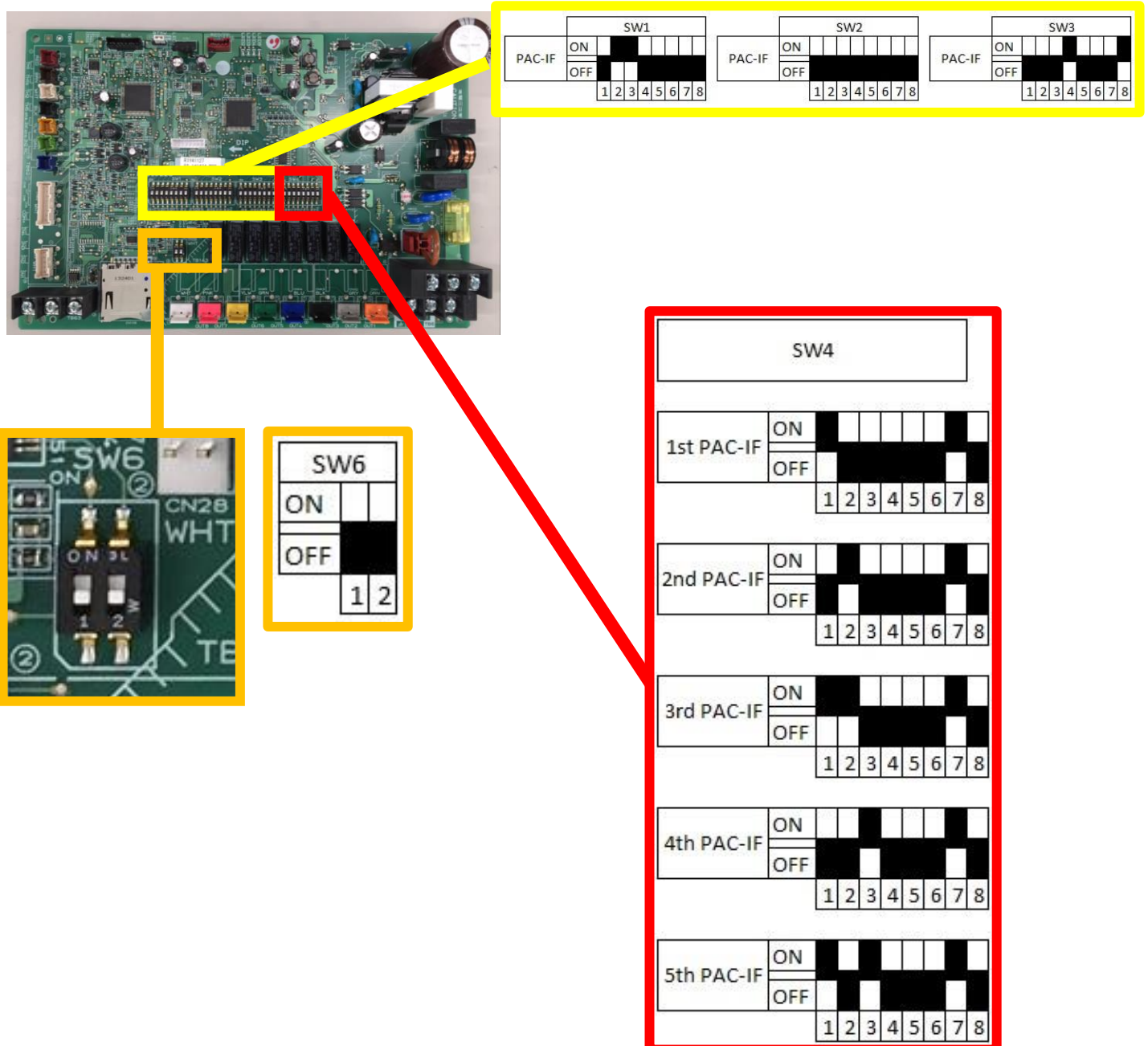



## E-OU and B-OU versions

If the card is faulty and needs to be replaced, make all the electrical connections as on the original card.

Make sure to also set the DIP SWITCHES on the new PAC-IF interface card as illustrated below.

The DIP SWITCHES of the SW1, SW2, SW3, SW6 must be set in the same way for all the PAC-IF interface cards in the switchboard of the WIZARDX unit.

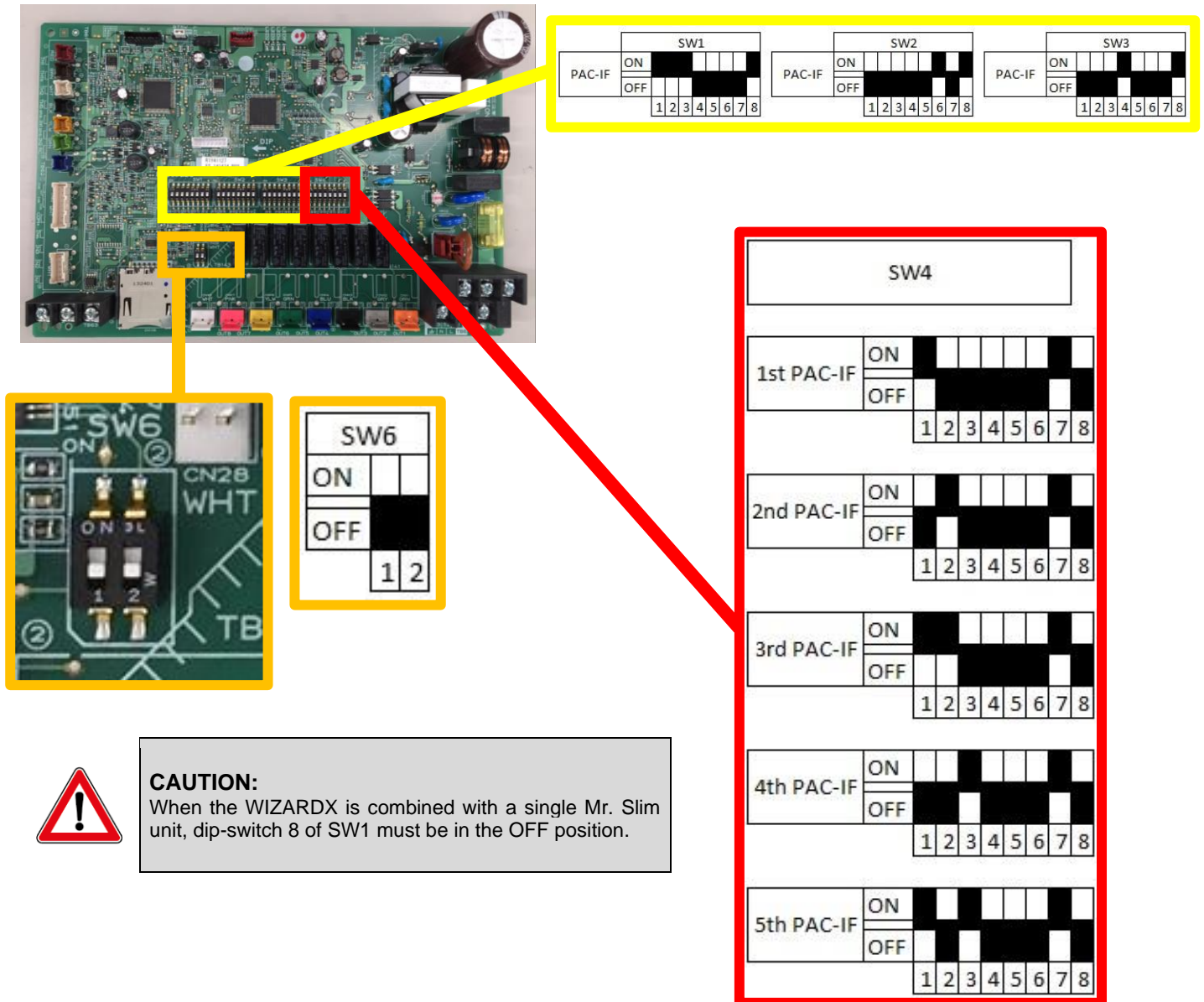

Irrespective of the type of control used, remove the "bridge" shown in the figure:

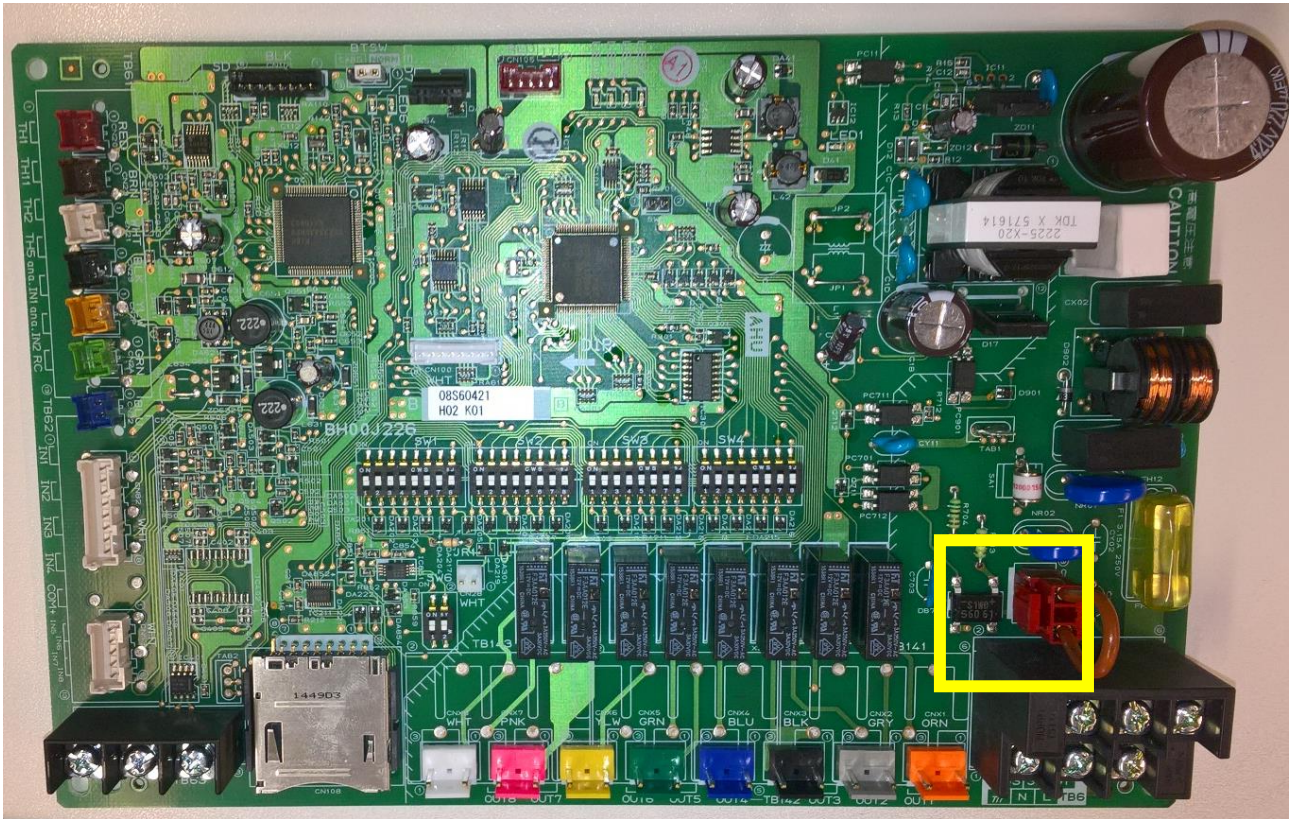

## 5 OPTIONALS

### Electric pre-heating coil

In the case of a particularly cold winter the machine must be equipped with the optional "Electric pre-heating coil" which helps to prevent freezing. The unit's control system is tripped automatically when the outdoor air temperature drops below -10 °C, activating the three stages of operation of the coil to increase the air temperature up to 5 °C.

Weight [kg]							
MODEL	3000	5000	7500	10000	12500	15000	20000
Electric pre-heating coil	20	34	34	44	44	46	56

### Electric post-heating coil

The electric post-heating coil can be used in winter to compensate for the defrost cycles of the outdoor units. In the case of defrost, one or more circuits of the direct expansion coil may temporarily produce cold air instead of the flow of hot air expected during normal operation in this season. The electric post-heating coil is activated during these short defrost cycles to heat the air and compensate for the unpleasant effect that cold air can produce when it enters a room. At the end of the defrost cycle, the direct expansion coil resumes operation as a heating body and the electric post-heating coil is deactivated.

In the B-OU version, the electric post-heating coil can also be used in the summer to compensate for dehumidification.

In the case of a particularly humid climate, the B-OU version can request the direct expansion coil to perform dehumidification, so that the air leaving the coil may reach particularly low values. This means the electric post-heating coil can be used to bring the delivery temperature back to the level required for comfort indoors; the coil regulates the supply of power according to three steps to allow for finer control of the required temperature.

The C-OU and E-OU versions do not have the dehumidification function; for these versions it is not, therefore, possible to use the electric post-heating coil to compensate for dehumidification.

<b>ELECTRIC PRE AND POST-HEATING COILS (CAPACITY CALCULATED FOR A TEMPERATURE DELTA = 5°C)</b>							
	3000	5000	7500	10000	12500	15000	20000
ELECTRIC PRE-HEATING COILS [kW]	5	8	12	16	20	24	32
ELECTRIC POST-HEATING COILS [kW]	5	8	12	16	20	24	32
CONSTRUCTION SPECIFICATIONS: - IP55 - GALVANISED STEEL FRAME - AUTOMATIC RESET THERMOSTAT CALIBRATED TO 90 °C - MANUAL RESET THERMOSTAT CALIBRATED TO 100 °C - NUMBER OF STAGES = 3							

Weight [kg]							
MODEL	3000	5000	7500	10000	12500	15000	20000
Electric post-heating coil	20	34	34	44	44	46	56

### Water pre-heating coil

Like the electric pre-heating coil, a hot water pre-heating coil can be provided. The control system is tripped automatically when the outdoor air temperature drops below  $-10\text{ }^{\circ}\text{C}$ , modulating the 3-way valve of the coil to increase the air temperature up to  $5\text{ }^{\circ}\text{C}$ .

Size of unit	Pre-heating		
	P [kW]	Q [l/h]	$\Delta P$ [kPa]
WIZARDX 3000	5.14	979	28.20
WIZARDX 5000	8.56	1631	23.20
WIZARDX 7500	12.84	2447	23.10
WIZARDX 10000	17.12	3262	13.60
WIZARDX 12500	21.40	4078	22.10
WIZARDX 15000	25.68	4893	22.00
WIZARDX 20000	34.24	6524	29.40

AIR IN:  $-15\text{ }^{\circ}\text{C}$  OUT:  $-10\text{ }^{\circ}\text{C}$

WATER IN:  $45\text{ }^{\circ}\text{C}$  OUT:  $40\text{ }^{\circ}\text{C}$

MODEL	Weight [kg]						
	3000	5000	7500	10000	12500	15000	20000
H <sub>2</sub> O pre-heating coil	14	20	24	32	36	42	56

### Water post-heating coil

Like the electric post-heating coil, a water post-heating coil can be provided that can bring the delivery temperature back to the values required for comfort indoors. A 3-way modulating valve controls the power supplied by the post-heating coil.

Like the electric post-heating coil, the water post-heating coil can be used in the winter to compensate for the defrost cycles of the outdoor units, or in the summer, only for the B-OU version, to compensate for forced dehumidification when this is required.

Size of unit	Post-heating		
	P [kW]	Q [l/h]	$\Delta P$ [kPa]
WIZARDX 3000	5.22	898	17.00
WIZARDX 5000	8.71	1497	14.10
WIZARDX 7500	13.06	2246	14.00
WIZARDX 10000	17.41	2995	8.30
WIZARDX 12500	21.77	3744	13.40
WIZARDX 15000	26.12	4492	13.30
WIZARDX 20000	34.83	5990	17.70

AIR IN:  $16\text{ }^{\circ}\text{C}$  OUT:  $21\text{ }^{\circ}\text{C}$

WATER IN:  $45\text{ }^{\circ}\text{C}$  OUT:  $40\text{ }^{\circ}\text{C}$

MODEL	Weight [kg]						
	3000	5000	7500	10000	12500	15000	20000
H <sub>2</sub> O post-heating coil	14	20	24	32	36	42	56

## Connecting the water coils

The WIZARDX units require hydraulic connections to the condensate drains and to the inlets and outlets of the pre and post-heating coils available as accessories.

The connections for the water system of the coils are indicated below:

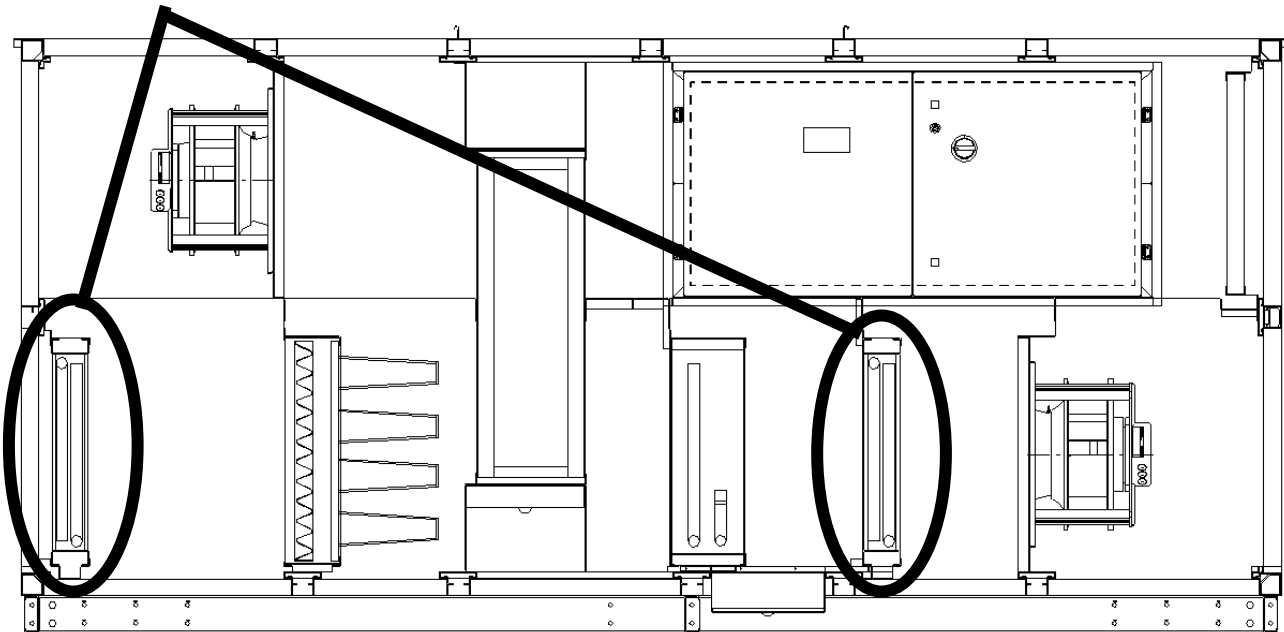

The inlet and outlet are marked with these labels affixed directly on the machine.



### INFORMATION:

Install an expansion vessel with a safety valve in the hydraulic circuit. The hydraulic circuit must be sized according to the applicable laws in force.

The hydraulic circuit must not obstruct the opening of the inspection doors of the WIZARDX unit, and must not obstruct removal of the heat exchanger.

A cover must be fitted for the servo drive when the unit is installed outdoors.

The servo drive must be installed in an area where the temperature is above  $-5^{\circ}\text{C}$ .

The pre and post-heating water heat exchangers are supplied with a hydraulic kit (as an additional package) consisting of:

- a three-way calibration valve with servo drive;
- pipes to connect the valve to the inlets and outlets of the exchanger;

After connecting the hydraulic kit to the manifolds of the coil, make the electrical connection by joining the pair of connectors (see the chapter "JOINING THE SECTIONS").

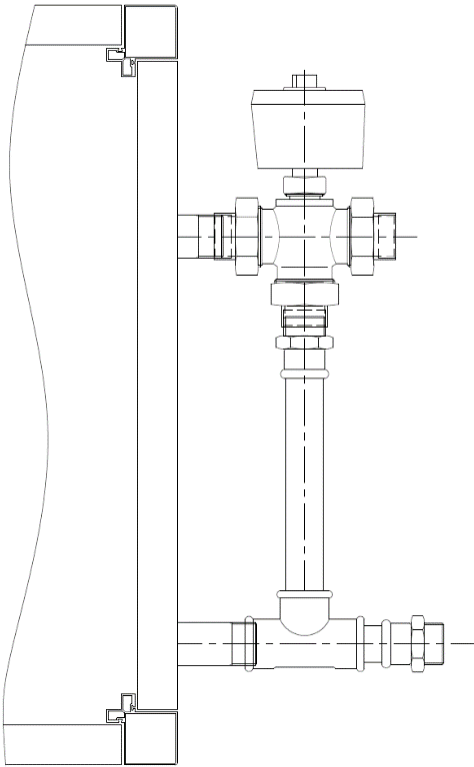

The dimensions of the connections, both for the pre and post-heating coils, are as follows:

MODEL		3000	5000	7500	10000	12500	15000	20000
IN / OUT								
ISO 7/1	Ø	1/2"	1/2"	3/4"	1"	1"	1"	1 1/4"

Below are recommendations on design of the hydraulic connection to the coils:

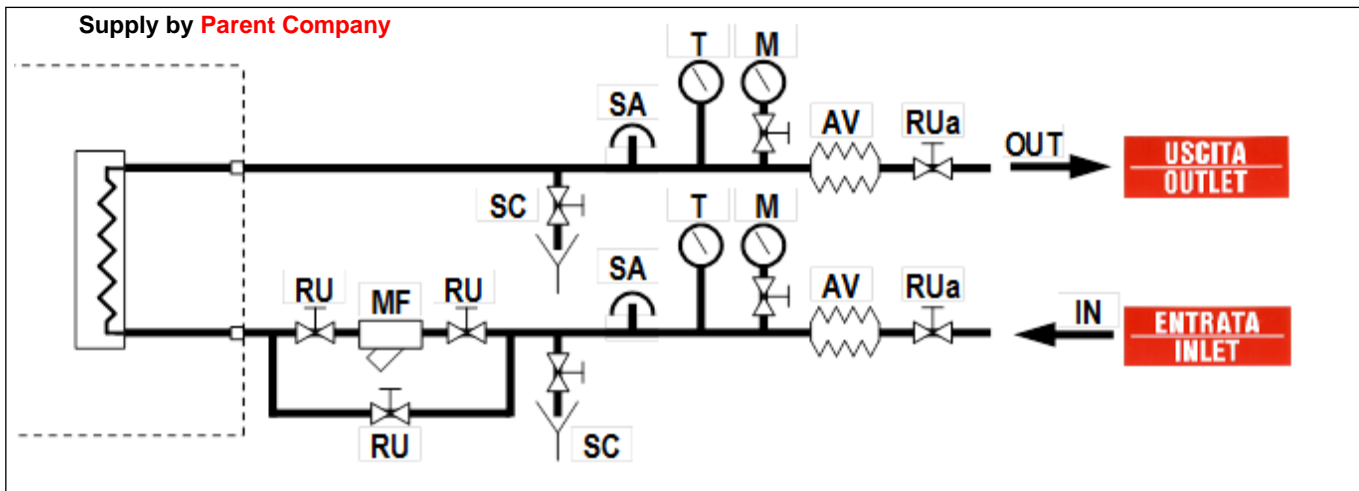

During the design phase, envisage the installation of the following components on the inlet water line:

- **AV - Anti-vibration:** to isolate the vibrations that can be transmitted from the system.
- **M - Pressure gauge** (with stopcock): indicates the water pressure in the inlet line.
- **T - Thermometer:** indicates the water temperature in the inlet line.
- **SA - Air vent:** to eliminate air in the inlet line.
- **SC - Drain valve:** to drain water out of the system. To be used also for connecting an external pump for chemical washing.
- **MF - Mains filter:** (with a system of RU valves for cleaning the filter): for trapping impurities in the system.

Assemble the following components on the water outlet line:

- **RUa - Shut-off valves:** for shutting off the supply of water to the machine during maintenance.
- **AV - Anti-vibration:** to isolate the vibrations that can be transmitted from the system.
- **M - Pressure gauge** (with stopcock): indicates the water pressure in the inlet line.
- **T - Thermometer:** indicates the water temperature in the outlet line.
- **SA - Air vent:** to eliminate air in the outlet line.
- **SC - Drain valve:** to drain water out of the system. To be used also for connecting an external pump for chemical washing.

Install an expansion vessel with a safety valve in the hydraulic circuit. The hydraulic circuit must be sized according to the applicable laws in force.



**CAUTION:**

Maximum operating pressure 10 BAR, including the hydrostatic head – PN10.

The connection pipes must be suitably supported so that they do not weigh down on the machine.

Avoid rigid connections between the machine and the pipes, and install vibration dampers.

For temperatures, minimum and maximum water flow rates and the volumes of water in the heat exchanger hydraulic circuit refer to the technical bulletin.

Any heating elements installed to prevent the pipes from freezing must be kept away from devices, sensors and materials that the heating elements could damage or cause to malfunction (for example, temperature sensors, plastic components and power cables).

The carrier fluid in the water circuits must be prevented from flowing in the reverse direction as this can damage the pumps or cause by-passes, affecting the flow and temperature of the system.

### Air filter

The standard unit is supplied with ISO COARSE 55% - ISO 16890 (G4 - EN 779:2012) synthetic filters + EPM1 50% - ISO 16890 (F7 - EN 779:2012) rigid bag filters on the delivery line, and ISO COARSE 55% - ISO 16890 (G4 - EN 779:2012) synthetic filters on the return line.

It is possible to ensure a higher degree of filtration on the delivery line and a better deodorising effect with EPM1 85% - ISO 16890 (F9 - EN 779:2012) rigid bag filters or activated carbon rigid bag filters, which are available on request and as OPTIONAL accessories. In the interest of ensuring the high performance and energy efficiency of the air handling unit, there must be a differential pressure switch for each filtering section of the control system of the WIZARDX units.

The controller triggers an alarm when the pressure switch detects a drop in pressure that exceeds the maximum permitted value, indicating the filter concerned.

After activation of the filter alarm, it is necessary to clean or replace the filter(s) concerned.

### Rainproof hood and mesh on external air intake

A rainproof hood with integrated anti-bird mesh is available on request for the external air intake. The accessory prevents small objects or drops of rain water from entering the machine through the air intake when there are no ducts connected to the external air intake and the machine is installed outdoors.

The unit is supplied with the hood already mounted (increase of the overall dimensions of about 150 mm).

Weight [kg]							
MODEL	3000	5000	7500	10000	12500	15000	20000
Rainproof hood + EA anti-bird mesh	4	7	10	14	17	19	26

### Roof

The "aluminium roof" accessory must be used as the main form of protection against bad weather when the machine is installed outdoors.

The roof is provided already mounted on the unit (if the machine is sent already assembled), or mounted on each section.

Weight [kg]							
MODEL	3000	5000	7500	10000	12500	15000	20000
Aluminium roof	17	23	25	29	32	38	44



### External, supply, return and exhaust air dampers

If the airflows in the network of air distribution ducts are shut off when the machine is stopped, it is possible to fit dampers on the external air intake, on the air supply line, on the air return line and on the exhaust air line. These are available as optional accessories. The dampers are provided already mounted on the machine and with a servo drive for opening and closing. The control system of the machine is connected to the servo drives which open and close the dampers according to the control logic. The individual dampers can be purchased separately.

Weight [kg]							
MODEL	3000	5000	7500	10000	12500	15000	20000
Supply air inlet damper	5	8	11	15	18	21	28
Supply air outlet damper							
Return air inlet damper							
Return air outlet damper							

### Increased useful static pressure of the fans

If a useful static head higher than the 250 Pa of the standard configuration is required for the air distribution ducts, an oversize version of both the delivery fan and the return fan can be provided to increase the useful static pressure up to 400 Pa.

**Note:** for model 12500 only, in the case of pressure at 400 Pa, the delivery fan weighs 10 kg more than standard.

### Variable speed heat recovery unit

The variable speed heat recovery unit is an optional component that can be installed in the place of the fixed speed heat recovery unit.

### Recirculation damper section (accessory)

If recirculation of a part of the extracted air is required, an additional section with motorised recirculation damper is available as an accessory.

The recirculation damper can be controlled in different ways:

With CO<sub>2</sub> probe, also available as an accessory. If the amount of CO<sub>2</sub> in the extracted air exceeds the threshold set on the WIZARDX controller, the external air intake damper will open and the recirculation damper will close, while if the CO<sub>2</sub> remains below the threshold the recirculation damper will open proportionally to reduce energy consumption.

Start-up with total recirculation. The unit starts up with the external air intake damper closed and the recirculation damper completely open. When the set conditions are reached, the machine starts working entirely with external air.

Periodic air renewal: the machine forces 100% of external air at precise intervals set on the controller. For the assembly of the "recirculation damper" section, see the chapter "JOINING THE SECTIONS".

The dimensional drawing of the "recirculation damper" section is supplied together with all the accompanying documentation.

MODEL	W	H	L	N. SECTIONS	WEIGHT
	[mm]	[mm]	[mm]		[kg]
3000	1000	1600	790	1	124
5000	1400	1600	790	1	150
7500	1500	2200	790	1	182
10000	1800	2200	790	1	202
12500	2000	2300	790	1	224
15000	2200	2360	790	1	238
20000	Not available				

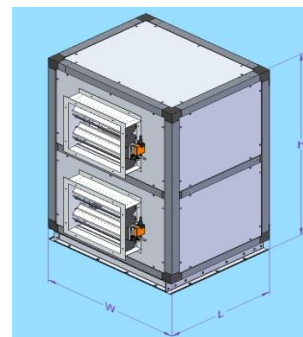

MODEL	W	H	L	N. SECTIONS	WEIGHT
	[mm]	[mm]	[mm]		[kg]
3000	1000	1600	750	2	130
5000	1400	1660	790	2	157
7500	1500	2260	790	2	191
10000	1800	2260	790	2	212
12500	2000	2360	790	2	236
15000	2200	2420	790	2	250
20000	2500	2820	860	2	290

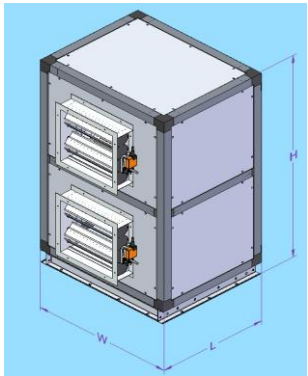

### CO<sub>2</sub> Sensor

The WIZARDX control system can be integrated with a CO<sub>2</sub> sensor. Once a threshold level has been set for the CO<sub>2</sub> content in the return air, the WIZARDX control system operates in the following ways:

- Air flow modulation on two levels, minimum and maximum: the air flow of the fans is set to the minimum level when the CO<sub>2</sub> is below the threshold level, and automatically set to the maximum level when the threshold is exceeded.
- Modulation in combination with the recirculation damper accessory: in this case the fans maintain the fixed flow rate while the recirculation damper is opened and closed as described in the paragraph on the accessory "Recirculation damper section". **STEAM HUMIDIFIER SECTION (ACCESSORY).**

MODEL	W	H	L	N. SECTIONS	WEIGHT
	[mm]	[mm]	[mm]		[kg]
3000	1000	1600	900	1	185
5000	1400	1600	900	1	223
7500	1500	2200	900	1	310
10000	1800	2200	1100	1	366
12500	2000	2300	1100	1	406
15000	2200	2360	1200	1	453
20000	Not available				

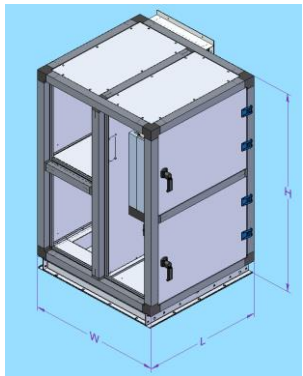

MODEL	W	H	L	N. SECTIONS	WEIGHT
	[mm]	[mm]	[mm]		[kg]
3000	1000	1660	900	2	194
5000	1400	1660	900	2	234
7500	1500	2260	900	2	326
10000	1800	2260	1100	2	385
12500	2000	2360	1100	2	427
15000	2200	2420	1200	2	476
20000	2500	2820	1300	2	538

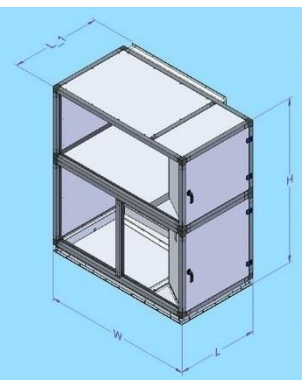

If humidification is required indoors, there is an additional section available as an accessory that has an immersed electrode steam generator connected to a steam distribution ramp located in the section for the supply of air. The section comes with a drip tray. The delivered steam flow rate is calculated according to the size of the WIZARDX unit and the power consumption of the steam generator is defined in relation to this. Specific probes detect the humidity to allow the main controller of the WIZARDX to regulate the steam generator accordingly by means of a special 0-10V signal.

Humidity control can be for the flow of supply or return.

The section is designed for quick mechanical and electrical connection. In this case, the switchboard of the WIZARDX is supplied with the power and protection parts required for use of the steam generator.

Before positioning and installation of the accessory, read the chapter "INSTALLING THE UNIT ON SITE". Follow all the instructions so as not to cause malfunctioning or breakage of the unit.

The steam generator needs to be connected to the hydraulic circuit for the supply and draining of water; observe the instructions in the user manual provided with the steam generator accessory. Refer to the user manual of the steam generator for the specifications of the supply and draining of water.

The accessory is powered directly from the switchboard of the WIZARDX unit.

See the chapter "JOINING THE SECTIONS" for the electrical and mechanical connection between the humidification section and the WIZARDX unit.

The section is equipped with a condensate collection tank for conveying the condensed steam towards the condensate drain of the tank. It is therefore necessary to set up a specific connection to the condensate drain on site, following the instructions in the chapter "hydraulic connection of the condensate drain".

The dimensional drawing of the "steam humidifier" section is supplied together with all the accompanying documentation.

#### Immersed electrode humidifier (optional component)

Do not use detergents or solvents for cleaning the plastic components.

To remove scale, use a solution containing 20% vinegar or acetic acid and then rinse with water.

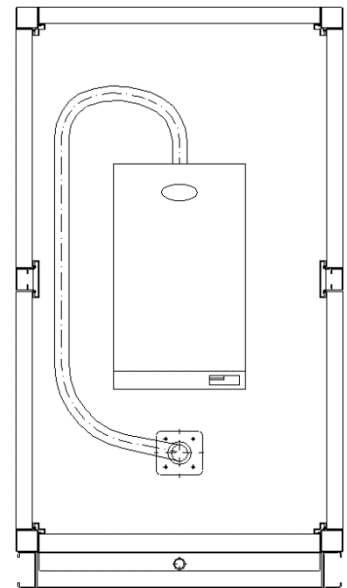

<b>STEAM HUMIDIFIER (FLOW CALCULATED FOR A DX = 2 g/kg THAT PERMITS RH<sub>supply</sub> = 50 % ALSO WITH AN EXTERNAL T OF = -5°C)</b>							
SIZE OF WIZARDX	3000	5000	7500	10000	12500	15000	20000
NOMINAL PRODUCTION OF STEAM [kg/h]	8	15	18	25	35	45	65
POWER ABSORPTION [kW]	6	11.2	13.5	18.7	26.2	33.7	48.7
CURRENT ABSORPTION [A]	8.7	16.2	19.5	27.1	37.9	48.7	70.4
POWER SUPPLY [V]	3x400V 50/60Hz						
NUMBER OF DISTRIBUTORS	1	1	1	1	1	1	2
DIAMETER OF DISTRIBUTORS [mm]	30	30	30	40	40	40	40
LENGTH OF DISTRIBUTOR [mm]	450	650	850	1050	1250	1250	1650
<b>CONSTRUCTION SPECIFICATIONS:</b>							
- UE***X IMMERSED ELECTRODE STEAM GENERATOR							
- ADDITIONAL SECTION WITH SAME STRUCTURE AND PANNELLING AS THE AHU							
- ADDITIONAL SECTION CONTAINING: CONDENSATE COLLECTION TANK, STEAM DISTRIBUTOR							
- STEAM GENERATOR IN A COMPARTMENT OF THE ADDITIONAL SECTION							

## Accessories/options that can be used even after installation of the unit

ACCESSORIES/OPTIONS	PURCHASABLE
Useful pressure 400 Pa	✓
Sorption variable speed rotary recuperator	✓
Steam humidification	✓
Electric pre-heating coil	✓
Electric post-heating coil	✓
H <sub>2</sub> O pre-heating coil	✓
H <sub>2</sub> O post-heating coil	✓
Supply air inlet damper	✓
Supply air outlet damper	✓
Return air inlet damper	✓
Return air outlet damper	✓
Recirculation damper (section with three dampers)	✓
CO <sub>2</sub> Sensor	✓
EPM1 50% - ISO 16890 (F7 - EN 779:2012) activated carbon rigid bag filter	✓
EPM1 85% - ISO 16890 (F9 - EN 779:2012) rigid bag filters	✓
Configuration with connectors and inspection doors on left side	X
Unit divided into five sections	X
Fully demountable unit	X
Rainproof hood + EA anti-bird mesh	✓
Aluminium roof	✓

## 6 DISPOSAL OF THE UNIT

For these types of operations contact specialist personnel recommended by the Manufacturer or its agent.

The WEEE directive 2012/19/EU prohibits disposal of the electrical and electronic equipment of the unit in mixed municipal waste. The following symbol indicates that the equipment must be separated.



Proper disposal of the electrical and electronic equipment helps reduce the risk of harm to human health and to the environment. The purchaser, who plays a key role in the reuse, recovery and recycling of this equipment, is invited to contact the local authorities, the waste disposal service, the retailer or producer to request the necessary information.



### CAUTION:

The circuit contains fluorinated greenhouse gas covered by the Kyoto Protocol. In accordance with the law, these must not be dispersed in the environment but collected and delivered to the retailer or collection centre.

When components are replaced, or when the entire unit is removed from the installation at the end of its useful life, the following requirements must be observed to minimise impact on the environment:

- the refrigerant gas must all be collected by specialist personnel with the necessary certification and delivered to the collection centres;
- the lubrication oil in the compressors and cooling circuit must be collected and delivered to the collection centres;
- the structure, the electrical and electronic equipment and the components must be sorted according to category and material and delivered to the collection centres;
- if the water circuit contains mixtures with antifreeze, these must be collected and delivered to the collection centres;
- observe the domestic laws in force.

## 7 FIRST DIAGNOSTICS

### 7.1 What to do if

Refer to the unit electronic controller interfacing manual.

### 7.2 Alarm Log

Refer to the unit electronic controller interfacing manual.

---

**MITSUBISHI ELECTRIC  
HYDRONICS & IT COOLING SYSTEMS S.p.A.**

**Head Office:**

Via Caduti di Cefalonia 1 - 36061 Bassano del Grappa (VI) - Italy

Tel (+39) 0424 509 500 - Fax (+39) 0424 509 509

[www.melcohit.com](http://www.melcohit.com)